

AD 684938

A FIELD GUIDE TO SIMPLE HF DIPOLES

by: C. Barnes, J. A. Hudick, and M. E. Mills

Prepared for:
United States Army Electronics Command
Fort Monmouth, New Jersey

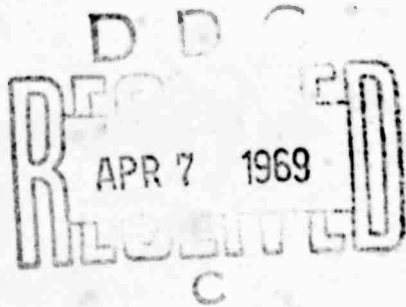

STANFORD RESEARCH INSTITUTE
Menlo Park, California

Reproduced by the
CLEARINGHOUSE
for Federal Scientific & Technical
Information Springfield Va. 22151

Sponsored by the Advanced Research Projects Agency
Under ARPA Order 371

DISTRIBUTION STATEMENT

This document has been approved for public
release and sale; its distribution is un-
limited.

**BEST
AVAILABLE COPY**

March 1967

A FIELD GUIDE TO SIMPLE HF DIPOLES

By: C. Barnes, J. A. Hudick, and M. E. Mills

Prepared for:

United States Army Electronics Command
Fort Monmouth, New Jersey

Contract DA-28-043 AMC-02201(E)
Order No. 28-043-J6-22600

SRI Project 6183

PREFACE

Under project Agile, Stanford Research Institute has supplied several teams to assist operating personnel in improving the performance of field radio networks. In this work, it has been observed that U.S. military and civilian antenna manuals often contain misleading information regarding the operation of field antennas and tend to be overly complex. Consequently, this guide has been prepared to assist in training personnel concerned with the construction of simple HF antennas in the field.

CONTENTS

PREFACE.	ii
LIST OF ILLUSTRATIONS.	v
I RADIO WAVES	1
A. General.	1
B. Wavelength and Frequency	3
C. Polarization	5
D. Attenuation.	6
E. Ionosphere	6
II ANTENNA CHARACTERISTICS	9
A. General.	9
B. Radiation Pattern.	9
C. Polarization	16
D. Resonant Frequency	17
E. Bandwidth.	19
III MULTIBAND ANTENNA	27
A. Description.	27
B. Construction	29
C. Pattern.	30
IV SINGLE-WIRE ANTENNA	31
A. Description.	31
B. Construction	31
C. Pattern.	32
Appendix--INSTALLATION AND OPERATION OF ANTENNAS AND EQUIPMENT.	35
1. Pole Locations.	35
2. Hanging the Multiband Antenna	36
3. Receiving Antenna	37
4. Grounding Equipment	37
5. Safety.	38

6.	Voltage-Standing-Wave-Ratio Bridge.	40
7.	Antenna Tuning Procedure.	41
8.	Field Strength Meter.	44
9.	Correct Wire Splice	45
10.	Power Cable Splice.	46
11.	BC-610 Modification	47
12.	Coaxial Cable Adapter Fabrication	47
13.	AN/GRC-9 and SCR-694 Radio Set Antennas . . .	48

ILLUSTRATIONS

Fig. 1	Communication Link.	1
Fig. 2	Same Antenna Used to Transmit or Receive.	2
Fig. 3	Diagram of Radio Wave Showing One Wavelength.	4
Fig. 4	Effect of Ionosphere.	7
Fig. 5	Dipole Antenna.	10
Fig. 6	High-Angle Radiation.	11
Fig. 7	Radiation Pattern of Half-Wave Dipole Antenna at Low Elevation Angle.	13
Fig. 8	Signal Strength Vectors at 30-Degree Elevation Angle from Typical Dipole Antenna	14
Fig. 9	Radiation Pattern of Half-Wave Dipole Antenna at 30 Degrees above Horizon	15
Fig. 10	Current Flow in Dipole Antenna.	17
Fig. 11	Equivalent Circuits for Antenna below, above, and at Resonance.	22
Fig. 12	Folded Dipole	23
Fig. 13	Length of Half-Wave Dipole Antenna.	26
Fig. 14	Multiband Antenna	28
Fig. 15	Single-Wire Antenna	32
Fig. A-1	Example of Antenna Pole Siting.	35
Fig. A-2	Dipole Adjustment Required to Change Resonant Frequency	43
Fig. A-3	Field Strength Indicator.	44
Fig. A-4	Correct Wire Splice	46
Fig. A-5	Incorrect Wire Splice	46
Fig. A-6	Power Cable Splice.	47
Fig. A-7	Coaxial Cable Adapters.	48

BLANK PAGE

I RADIO WAVES

A. General

Radio communication is carried on by means of radio waves traveling from the sending station to the receiving station as shown in Fig. 1. At the sending end, the radio waves are launched into space by an antenna. At the receiving end, a similar antenna intercepts some of the radio waves and directs them down to the receiver.

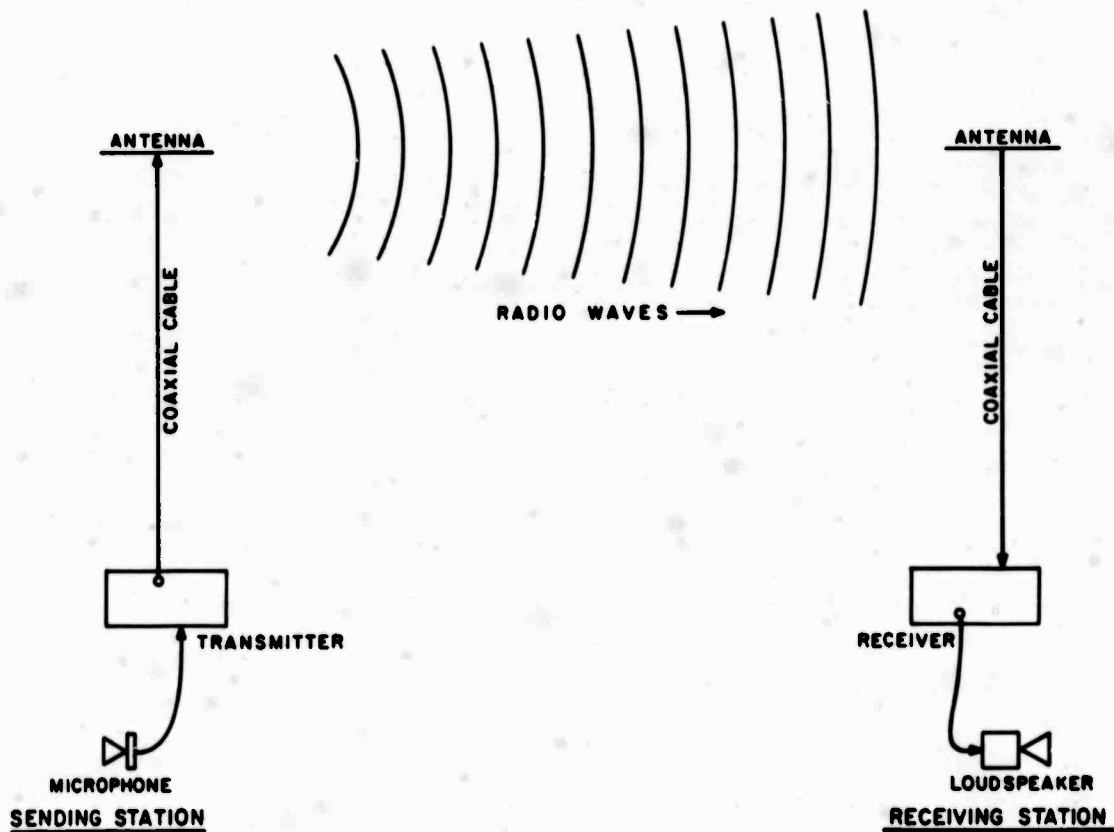

8-9103-2

FIG. 1 COMMUNICATION LINK

From this you can see that the antenna performs a very important service. The antenna is the place where alternating electric currents, which flow up a coaxial cable, are changed into radio waves that can travel through space. At the receiving end the antenna does the reverse: It changes radio waves back into electric currents.

One important thing to know about antennas is that the same antenna can do both of these things; any antenna that can transmit a signal can also receive one. Therefore, when we talk about the design of antennas it is customary to talk about the transmitting antenna only, because it is understood that the receiving antenna can be exactly the same. In fact, it is general practice to use the same antenna for both transmitting and receiving by simply switching it back and forth between a transmitter and a receiver, as shown in Fig. 2. In this discussion, we talk only about transmitting antennas, with the understanding that what works for transmitting will work equally well for receiving.

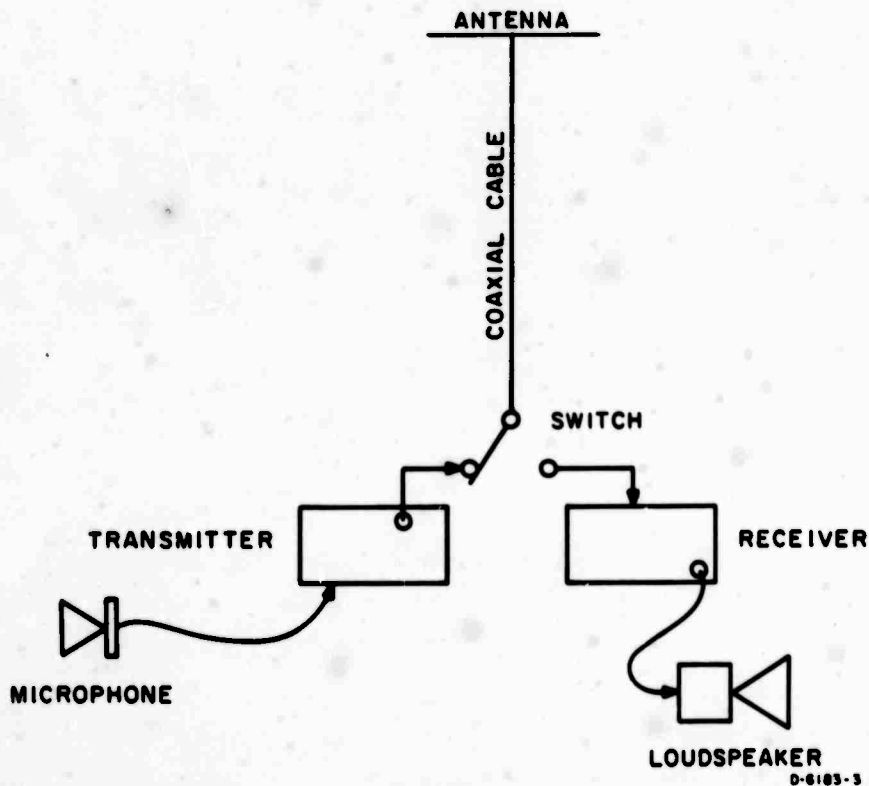

FIG. 2 SAME ANTENNA USED TO TRANSMIT OR RECEIVE

To be able to install and maintain an antenna, one must have some understanding of radio waves and the way they behave. Detailed knowledge of wave propagation is not necessary, but a few basic principles must be understood.

Almost any kind of antenna will radiate a signal, but the antenna is not good if it does not radiate enough signal or if it sends the signal off in the wrong direction. Our purpose here is to discuss only those features of radio wave transmission that have some bearing on the installation and maintenance of a high-frequency (HF) antenna system.

B. Wavelength and Frequency

No one understands exactly what a radio wave is made of, so its exact nature cannot be clearly explained. The best we can do is to compare radio waves with other forms of waves with which we are familiar and to say "In some ways they are like this," or "In some ways they are like that," and thus build up a picture of how radio waves behave.

Radio waves may be compared to waves started on the surface of a pond (when there is no wind) or to waves traveling along a rope when one end of it is shaken. The waves get smaller as they radiate out from the starting point, until at a sufficient distance they are too small to be detected. When a stone is thrown into a pond, the water waves radiate in expanding concentric circles; radio waves from an antenna radiate in expanding concentric spheres. When one wave follows after another in a long succession of waves (as they normally do), we have what is called a wave train. When a transmitter is sending a signal, its antenna is launching into space a wave train in which the waves are all traveling on straight lines directly away from the antenna. These radio waves pass through most nonconducting substances such as wood or air, but they are reflected or absorbed by conducting materials such as metal rods or the earth.

Two important terms are constantly used in reference to a wave train of radio waves: the wavelength and the frequency. If one can imagine for the moment that radio waves are like waves on water, then the wavelength is the distance from the top of one wave to the top of the next, as shown in Fig. 3. Thus the wavelength is the distance from any point on one wave to a corresponding point on the next wave. In Fig. 3 look at the distance between Points A and B and between

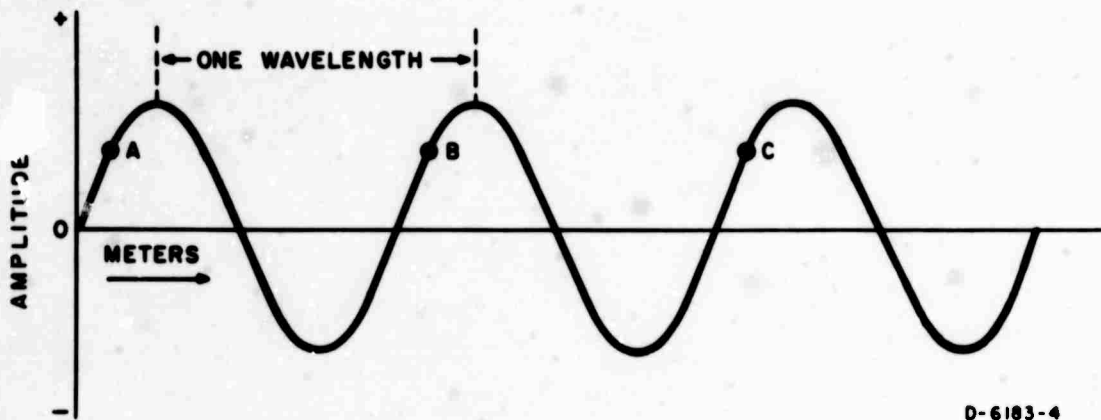

FIG. 3 DIAGRAM OF RADIO WAVE SHOWING ONE WAVELENGTH

Points B and C; these distances also represent 1 wavelength. The distance from A to C represents 2 wavelengths. Imagine the waves moving along from the sending station to the receiving station. The frequency is the number of waves that go by a fixed point in 1 second; in other words, the frequency is the number of waves the antenna radiates in 1 second. This is exactly the same as the frequency of the transmitter.

All the radio waves in a wave train travel through space at the same speed, like cars in a railroad train, so the wavelengths are the same everywhere. The distance between the cars on a railroad train does not change as it moves along; the cars are just as far apart at the end of a trip as they were at the beginning. The same is true of a train of radio waves. Once they are launched, they travel at a constant speed and a constant wavelength. However, if the frequency of the transmitter is made higher than it was before, the new radio waves are then closer together. There is a definite relationship between the frequency and the wavelength of a radio wave, which is expressed in the following formula:

$$w = \frac{300}{f} ,$$

where

w = wavelength in meters

f = frequency in megacycles per second (Mc/s).

Example: A transmitter is operating at a frequency of 10 Mc/s. What is the wavelength of the signal radiating from the antenna? Using the above formula, we get

$$w = \frac{300}{10} = 30 \quad .$$

The wavelength is 30 meters.

Radio waves always travel through space or air at the same speed, regardless of their frequency. Ordinarily, you will not be concerned with the velocity of travel of radio waves. They go so fast that you can assume that the signals arrive at the receiver at the same time that you are sending them from the transmitter. It is interesting to note, however, that radio waves travel 300,000 kilometers (km) per second. In spite of this high speed, the distance between the waves does not change during the trip any more than the distance between railroad cars changes during their trip.

C. Polarization

Radio waves consist of an alternating electric field combined with an alternating magnetic field. For this reason, radio waves are sometimes called electro-magnetic waves. Here we will be concerned only with the electric field. If the electric field is alternating in an up and down direction, the field is said to be vertical, and the waves are said to be vertically polarized. If the electric field is alternating in a direction parallel to the earth's surface the field is said to be horizontal, and the waves are said to be horizontally polarized.

If a person fastens one end of a rope to a tree, stretches the rope out to full length, and then shakes the end up and down, he will be generating vertically polarized waves. If he shakes the rope right and left, he will be generating horizontally polarized waves.

Generally speaking, a vertical antenna radiates vertically polarized radio waves, and a horizontal antenna radiates horizontally

polarized radio waves, although (as we shall see later) this is not always the case.

D. Attenuation

We have seen that radio waves get smaller in amplitude as they travel out from the transmitting antenna. Therefore the farther away you go from a transmitter, the weaker the signal becomes. This decrease in signal strength is caused by the fact that the energy in the wave has to spread out over larger and larger spheres as the distance from the source is increased. This loss in signal strength is known as attenuation. Long paths naturally have more attenuation than short paths. Signal is also lost in the coaxial cables used to connect the antenna to the transmitter (or to the receiver), and this loss is also called attenuation. It occurs because the radio signal traveling along the cable actually heats up the center conductor and the dielectric insulation. Cable attenuation is generally not important at HF frequencies for lengths under 50 meters.

E. Ionosphere

For all practical purposes you can assume that radio waves travel in straight lines away from the antenna, as shown in Fig. 4(a). Imagine, for a moment, the earth without an ionosphere. Then a radio signal could not be sent to a station on the other side of a mountain or so far away as to be over the curve of the earth. Radio signals will not pass through the earth, so it would be impossible for the receiver shown in Fig. 4(a) to pick up a signal from the transmitter. The transmitting antenna in Fig. 4(a) is radiating signals in all directions, but none of them would reach the receiving antenna.

Luckily, however, there is a region of ionized gas located high above the surface of the earth. This region, known as the ionosphere, reflects HF radio waves as shown in Fig. 4(b). If you examine Fig. 4(b), you will see that, if the transmitting antenna radiates in all directions, some of the radio waves will happen to hit the ionosphere at the right place to be reflected down to the receiver. All the other radio waves which do not hit the receiving antenna are wasted.

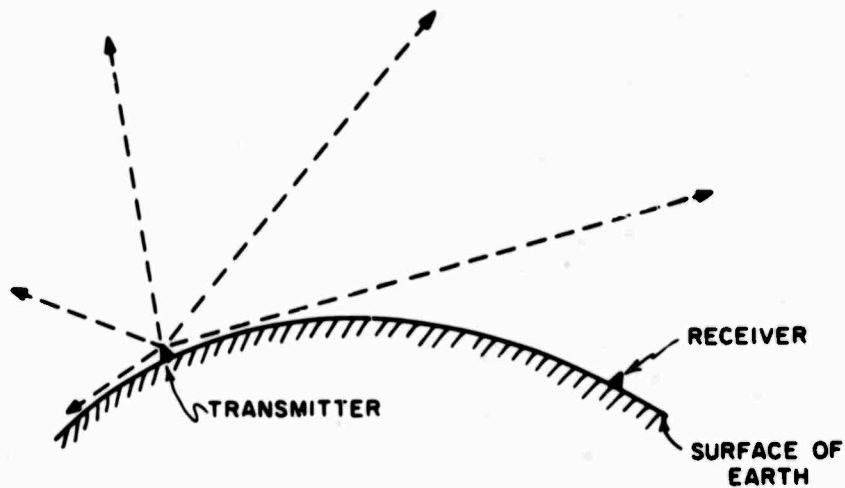

(a) WITHOUT IONOSPHERE

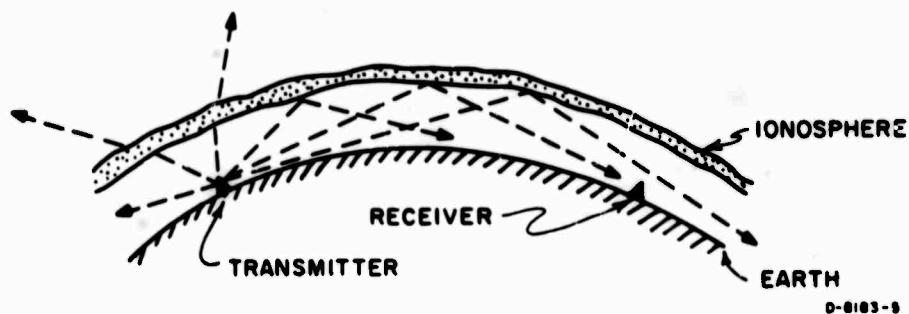

(b) WITH IONOSPHERE

FIG. 4 EFFECT OF IONOSPHERE

Radio waves are reflected by the ionosphere in much the same way that a beam of light is reflected by a pane of glass. If you shine the light directly at the glass, most of it will go through; but if you shine the light at the glass at an angle, it will be reflected. This is indicated in Fig. 4(b) by the radio signals above the antenna penetrating the ionosphere and passing on through it to outer space, while the radio signals that strike the ionosphere at a grazing angle are reflected.

The ionosphere is not a single stable reflector--in fact, quite the contrary. It consists of several layers of ionized gas which are constantly shifting about in height and in density. The ionosphere is formed during the day by the sunlight striking the atmosphere.

During the night, in the absence of sunlight, the ionosphere tends to disappear, but it does not disappear altogether. Each day the ionosphere is formed again by the sunlight. Therefore, high-frequency signals may fade out at night because they are not reflected as well then as they are during the day.

An important factor is that a high-frequency radio wave penetrates through the ionosphere more easily than a low-frequency wave does. A high frequency that can be used for sending a message during the daytime when the ionosphere is a good reflector may not work at night when the ionosphere decreases in density, because the radio waves will then go right through. If the high-frequency radio wave passes completely through the ionosphere, the message will not reach its destination. To prevent this, a lower frequency should be used at night, because low frequencies reflect better than high frequencies, and some of the ionosphere remains all night. However, low frequencies cannot be used in the daytime because of another ionospheric effect. During the daylight hours, a different layer forms along the bottom of the ionosphere that absorbs low-frequency signals (below 5 Mc/s) without reflecting them. For this reason, signals from low-frequency radio stations can be heard better at night, because they are absorbed by the bottom layer of the ionosphere during the day. Therefore, during the daytime the radio operator must use a frequency high enough to get through this absorbing layer but low enough to be reflected by the layers above. To do this, the best policy is to use the highest frequency that will be reflected back to earth. This is known as the Maximum Usable Frequency, or MUF. Charts are published showing the MUF predicted for different times. These charts help the radio operator select which of his assigned frequencies is likely to work best. The height and the condition of the ionosphere depend upon sunlight, which varies with the time of day and with the season of the year. Thus reflections from the ionosphere cannot be relied on to remain constant for long. The selection of the proper frequency for any given set of conditions is often a matter of trial and error.

II ANTENNA CHARACTERISTICS

A. General

The function of an antenna is to send out or to receive radio waves. As stated previously, an antenna that can do one can do the other. Therefore, to simplify the explanation, it is assumed here that the antenna is used for transmitting, and the description of its operation is oriented in that direction.

An antenna usually consists of a wire or a metal rod mounted high above the ground in a clear space. There are many types of antennas, each designed for a different frequency or a different purpose. One excellent antenna well suited for sending messages at HF frequencies over distances of 0 to 400 km is the dipole. A dipole antenna is a wire a little less than 1/2 wavelength long, divided in the center and connected to a coaxial cable, as shown in Fig. 5. The center conductor of the cable is connected to one half of the dipole and the outer conductor to the other half. The antenna shown in Fig. 5 is called a half-wave dipole.

The most important properties of an antenna are the radiation pattern, polarization, resonant frequency, and bandwidth. These are discussed in this chapter.

B. Radiation Pattern

The radiation from an antenna never has equal intensity in all directions. The intensity may even be zero in some directions, while in other directions a strong signal is radiated. The best antenna is one that radiates its strongest signal in the direction you want it to go--toward the receiver.

The direction toward the receiver is not always a straight line from the sending station to the receiving station. In fact, quite the reverse is true: The signal usually travels by reflecting off the ionosphere. When the signal is being sent over a 400-km path, the radio waves leave the antenna at an angle α above the horizon,

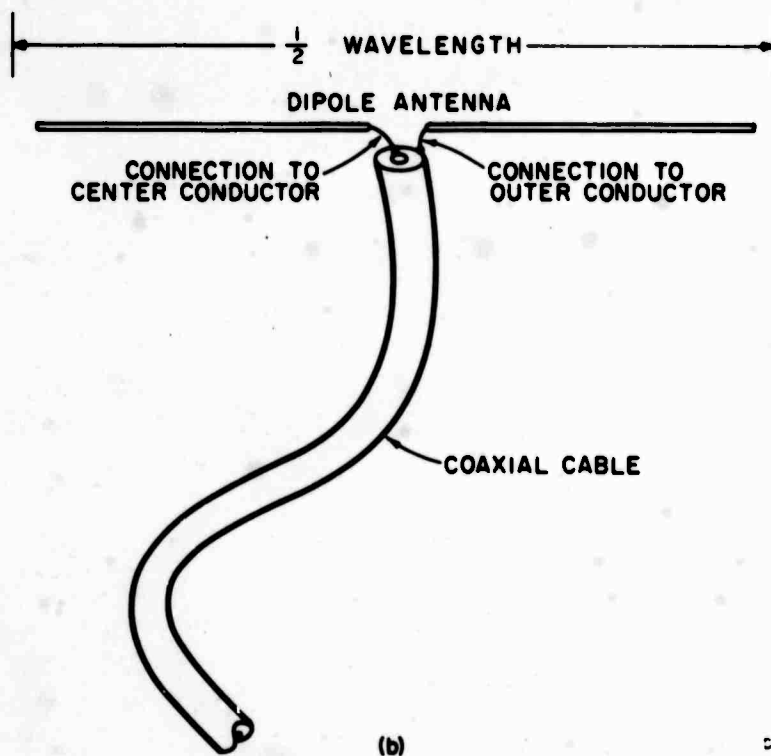
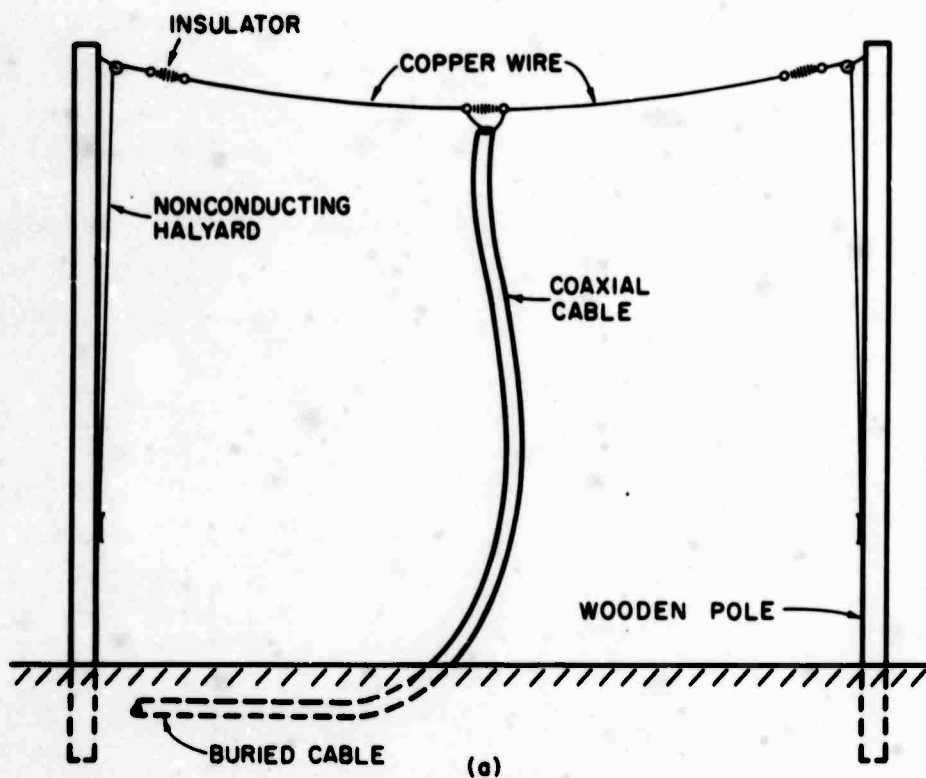

C-6 83-69

FIG. 5 DIPOLE ANTENNA

as shown in Fig. 6. (They also arrive at the receiving antenna at the same angle α .) Radio waves that leave the transmitting antenna

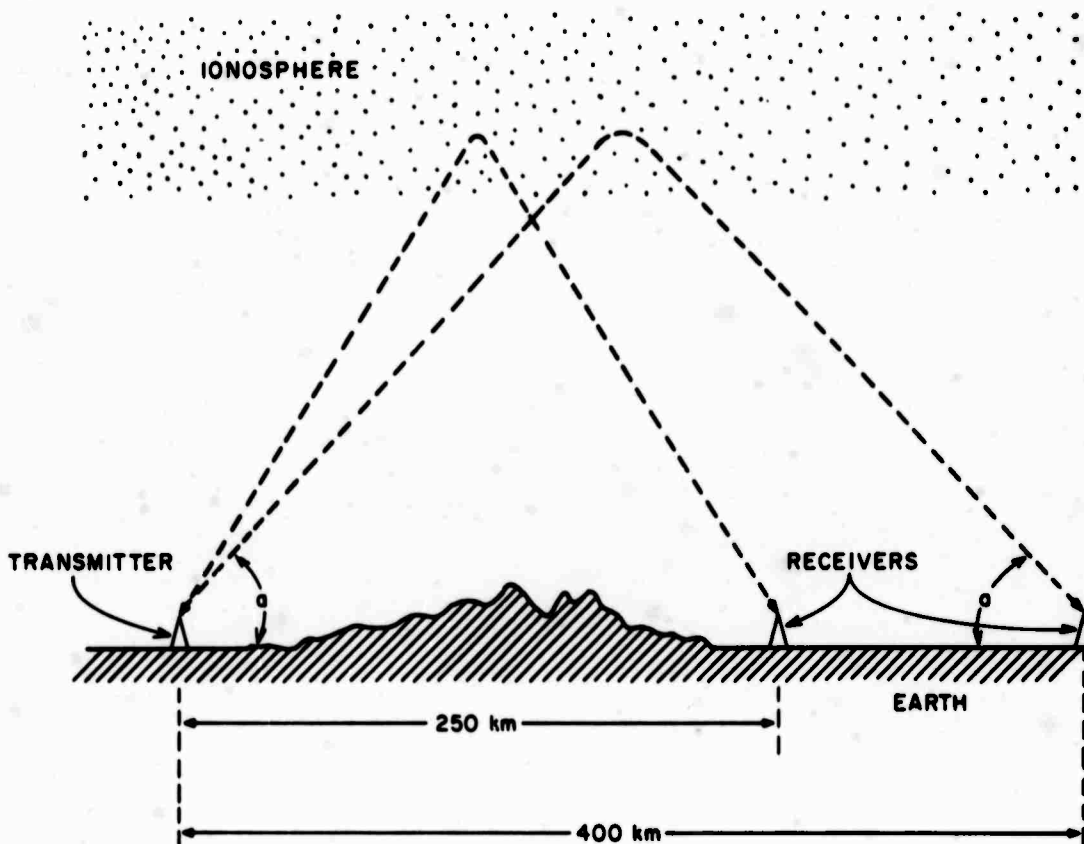

FIG. 6 HIGH-ANGLE RADIATION

0-6183-7

at a steeper angle return to earth at a shorter distance, possibly at 250 km (as shown in Fig. 6), where there might be another receiver. Radio waves that leave the antenna going straight up are reflected straight back down again to their starting point, if their frequency is low enough. (High-frequency radio waves are more likely to go through the ionosphere than low-frequency waves, especially if they hit it at a perpendicular angle.) By looking at Fig. 6 you can easily see that, if we want to send signals to a receiver less than 400 km away, the radio waves of use to us are going to leave the antenna at a steep angle. The height of the ionosphere varies

between 100 and 300 km; under these conditions, the angle α will be between 30 and 90 degrees for sending messages out to 400 km.

The horizontal dipole antenna has been selected as the best antenna to use under these conditions because it puts out a strong upward signal, and it radiates a good signal to every point of the compass at angles more than 30 degrees above the horizon.

At low take-off angles, the signal radiated is small and is not equal all the way around, being less off the ends of the dipole. At zero degrees elevation ($\alpha = 0^\circ$), practically no signal is radiated in any direction from a horizontal dipole antenna.

A diagram that shows the strength of the radiation leaving an antenna in different directions is called an antenna pattern diagram. Figure 7 is an antenna pattern diagram showing the amount of signal radiated at a low angle from a horizontal half-wave dipole antenna. This is a bird's-eye view, looking down on the antenna. Imagine the antenna located at the center of the diagram, at point O. The line XY indicates the direction of the half-wavelength long wire used to make the antenna, but the length of XY has no significance. The lines OA, OB, OC, OD, OE, and OF are vectors showing the signal strength in various directions. The length of a vector represents the strength of the signal in the direction the vector is pointing. The longest vector is OE; this indicates that the maximum signal is radiated at right angles to the antenna wire. If enough vectors are drawn to cover all directions from the antenna, it is then possible to draw a curved line through the points of all the vectors, as shown by the dashed line in Fig. 7. This dashed line is the antenna pattern; it is usually drawn as shown in the bottom half of Fig. 7, without the vectors.

The antenna pattern shown in Fig. 7 is not very useful to you, because it represents only the radiation from the antenna very close to the surface of the earth, whereas, as explained previously, the only radio waves that are likely to reach a receiver a long distance away are those that leave the transmitting antenna at a high angle

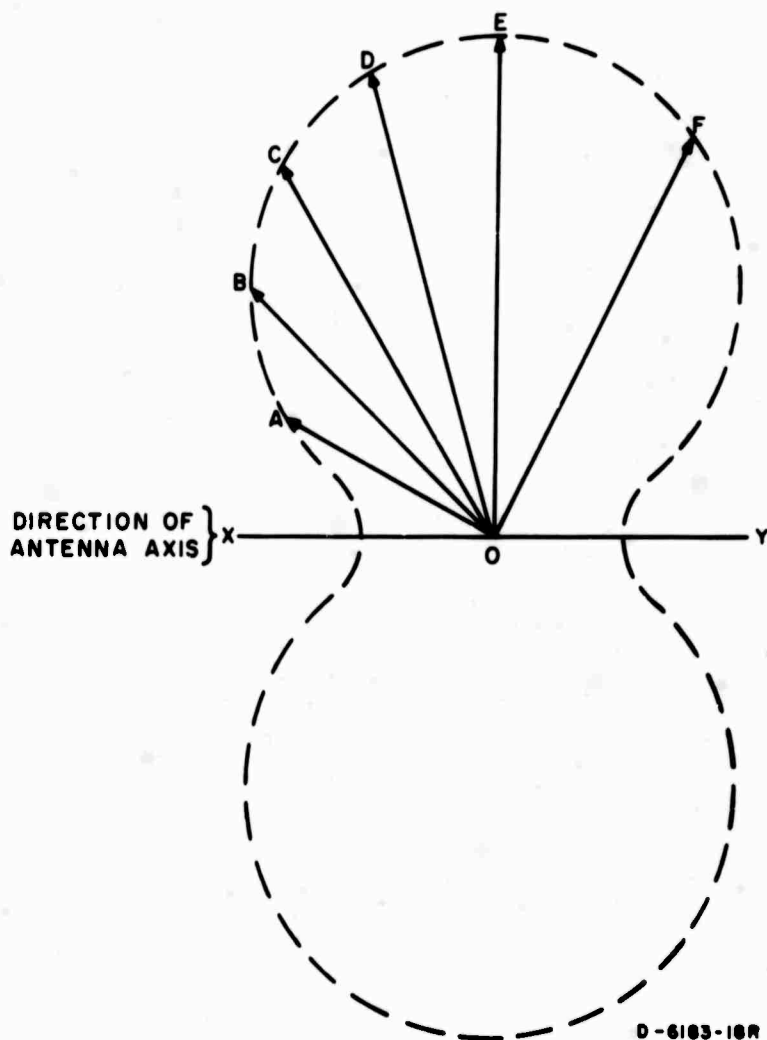

FIG. 7 RADIATION PATTERN OF HALF-WAVE DIPOLE ANTENNA AT LOW ELEVATION ANGLE

(a in Fig. 6). Therefore, to judge antenna performance, it is more useful to have an antenna pattern showing the radiation at 30 degrees or more above the horizon. Figure 8 is a diagram showing the signal strength (represented by vectors) radiated from a typical half-wave dipole antenna at 30 degrees above the horizon. As you can see, it radiates a good signal in all directions. Again, the dashed line drawn around the cone at the ends of the vectors represents the actual antenna pattern. To get a better idea of the exact shape of this pattern, it is customary to plot it on a flat piece of paper as shown in Fig. 9. This is a dashed-line graph in which the distance of each dash from the center is proportional to the signal strength in that direction. As you can see, at 30 degrees above the horizon,

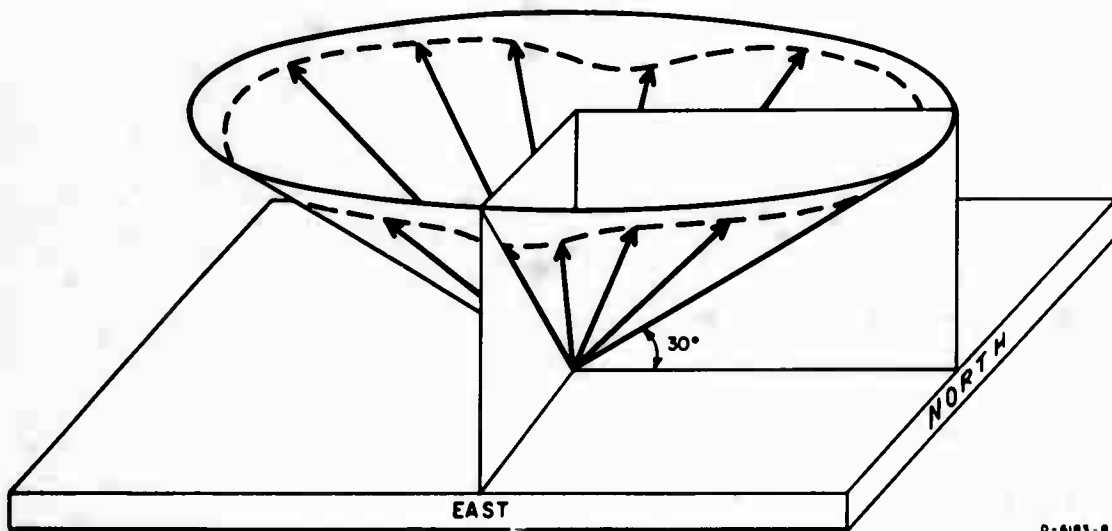

FIG. 8 SIGNAL STRENGTH VECTORS AT 30-DEGREE ELEVATION ANGLE FROM TYPICAL DIPOLE ANTENNA

the strongest signal is radiated off the sides of the antenna wire, but the signal radiated off the ends is not much less. At take-off angles above 30 degrees, the dipole antenna pattern changes to a shape more nearly resembling a circle, so that it has almost equal radiation in all directions for angles near the zenith.

The patterns shown in Figs. 8 and 9 apply only to horizontal dipole antennas (1) whose length does not exceed $1/2$ wavelength and (2) mounted less than $1/4$ wavelength above the ground. These patterns do not apply to antennas that are higher than $1/4$ wavelength above the ground. In the example given on page 5, it is shown that radio waves at a frequency of 10 Mc/s have a wavelength of 30 meters. Therefore, you can see that in this example $1/4$ wavelength would be $7-1/2$ meters, and an antenna to be used at 10 Mc/s should be no more than $7-1/2$ meters above the ground, if you want it to have the pattern shown in Fig. 9.

It is evident from Fig. 9 that it does not make much difference which way the antenna is aligned when it is put up. For sending signals over a mountain or over the curve of the earth, the antenna will work almost equally well in any direction. Therefore, the antenna can be erected by using the most convenient supports available

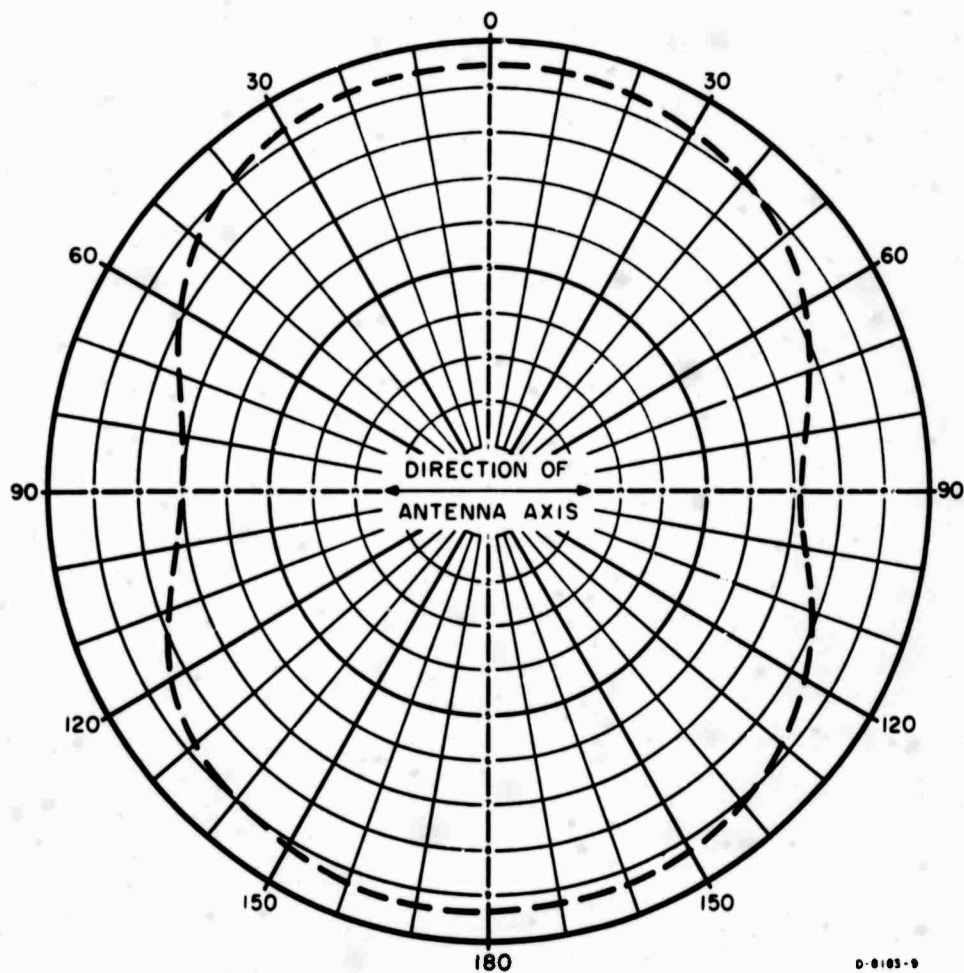

FIG. 9 RADIATION PATTERN OF HALF-WAVE DIPOLE ANTENNA
AT 30 DEGREES ABOVE HORIZON

without regard to the direction of its axis. Even for sending signals to receivers only 1 km away, the orientation may not matter, because if the receiver does happen to be located off the end of the transmitting antenna and does not receive the direct signal, it may still receive a signal reflected from the ionosphere if the frequency is low enough.*

* In one situation the orientation of a horizontal dipole does matter: when the radio signal is being sent almost straight up (reflecting off the ionosphere at or near a 90-degree angle) in an area where the earth's magnetic field is horizontal. This situation occurs when the transmitter and receiver are within the equatorial region defined by 20 degrees North and 20 degrees South Magnetic Latitude. In this case, due to the interaction of the magnetic field on the charged particles in the ionosphere, which are set in motion by the radio signal, some advantage is gained by aligning both the antennas on magnetic north-south lines, regardless of the direction from one station to the other.

C. Polarization

The radio waves leaving an antenna do not have the same polarization in all directions. The waves leaving the side of a horizontal dipole are horizontally polarized. That is, a half-wave dipole aligned north and south radiates horizontally polarized signals to the east and to the west. Also, the same antenna radiates signals that are essentially vertically polarized to the north and to the south, except at zero-degrees elevation, where it radiates nothing. At intermediate directions above the horizon, it radiates intermediate polarizations. However, this usually does not concern anyone, for the polarization is further changed by the ionosphere. When the radio waves hit the ionosphere, they do not actually reflect off the bottom of it; they penetrate part way through. The higher the frequency, the further they penetrate. Figure 6 shows the radio waves entering the ionosphere, bending around a curve, and heading back to earth. While the waves are traveling through the ionosphere and being forced around the curve (refracted), their polarization is changed. The waves do not have the same polarization when they leave the ionosphere that they had when they went in; furthermore, the polarization angle of the radio waves leaving the ionosphere changes from minute to minute as the ionized gas layers shift in position and density. Therefore, there is no way to predict what the polarization of the downcoming sky wave will be; it is just as likely to be vertical as it is to be horizontal, or any intermediate angle. The receiving antenna can pick up this signal most of the time; however, since the polarization is changing all the time, there are times when the antenna cannot pick up the signal. This occurs when the polarization of the incoming signal is at right angles to the polarization of the antenna. Luckily, this situation usually lasts only a few seconds. This is one of the reasons for signal fading, and such fading will occur regardless of the polarization of the transmitting or receiving antennas. If a signal fades for this reason, a switch to another antenna might improve matters, but it would have to be done extremely quickly.

D. Resonant Frequency

A dipole antenna (such as the one shown in Fig. 5) operates properly at only one frequency, the frequency at which it is resonant. Each dipole antenna has its own resonant frequency, which depends on its length. Many other things have resonant (or natural) frequencies besides antennas. For example, consider a child's swing: A swing has a natural frequency, or period. When you are pushing someone in a swing, you have to push it at the right time in each cycle in order to keep it going up equally high on each swing. If you push too soon or too late, you will only cause the swing to slow down. In the same way, alternating current in a cable that is driving a dipole must change directions at the same frequency that the current naturally swings back and forth in the dipole.

Electric current in a conductor consists of the flow of small particles called electrons. Figure 10(a) represents a dipole with electrons in it. When the transmitter is turned off, the electrons distribute themselves evenly throughout the dipole, as shown. All

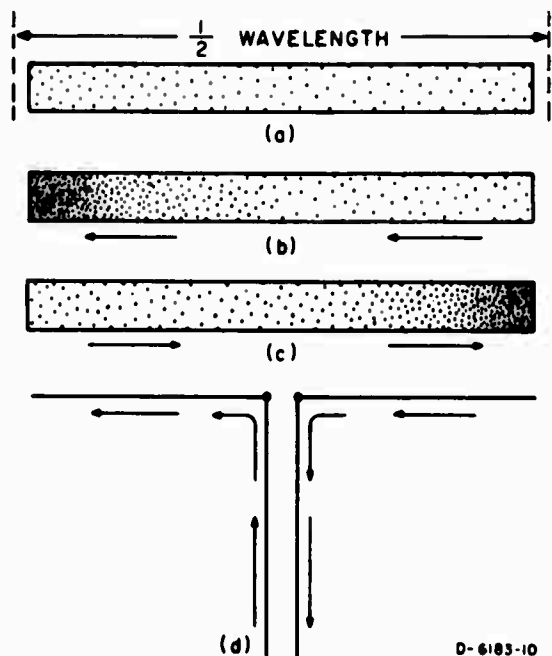

D-6183-10

FIG. 10 CURRENT FLOW IN DIPOLE ANTENNA

electrons repel each other and try to get as far from each other as possible; that is how they achieve the uniform distribution shown in Fig. 10(a). When the transmitter is turned on, the electrons flow back and forth from end to end as shown in Figs 10(b) and (c). First, the electrons flow to the left and get crowded together in one end as shown in Fig. 10(b). Second, since the electrons repel each other, they push off to the right and get crowded together at the other end, as in Fig. 10(c). If the signal coming up the coaxial cable keeps pushing them at the correct time in each cycle, the electrons (which push against each other with an elastic force) will continue to bounce back and forth from end to end. You can imagine this by looking alternately at Figs. 10(b) and (c). The arrows show the direction of electron flow required to get the electrons into the position shown. The electrons take a certain length of time to get from one end to the other, and the longer the dipole, the longer the time is. That is why a long dipole resonates at a lower frequency than a short one.

The difference between voltage (volts) and current (amperes) in a dipole is also illustrated by Figs. 10(b) and (c). You can see that the maximum flow of current is going to be in the middle of the dipole. An observer at the center of the dipole would see the electrons rush past, first one way and then the other. The center is a maximum current point. Very little current flows near the ends of the dipole; in fact, at the extreme ends there is no current at all, for there is no place for it to go. However, at the ends of the dipole, there is a great change of voltage; when the electrons are densely packed, this represents a negative voltage, and when there is a scarcity of electrons, it represents a positive voltage. Thus you can see that the voltage at each end swings alternately positive and negative. An end of a dipole is a maximum voltage point.

The top three diagrams in Fig. 10 show a dipole not connected to anything. Actually, the dipole antenna must be connected to a transmission line. The place where this line is attached to the dipole is called the feed point. The feed point is usually in the

middle of the dipole, so that each half is $1/4$ wavelength long. The transmission line leading from the transmitter to the feed point of a single-wire dipole antenna, such as that shown in Fig. 5, should be a coaxial cable. However, in order to illustrate the direction of current flow in the transmission line, we will imagine the antenna connected to a parallel-wire transmission line as shown in Fig. 10(d).

If the dipole is separated in the middle by an insulator and connected to a parallel-wire transmission line, the current during one half cycle flows as shown by the arrows in Fig. 10(d). During the other half of the cycle, the current reverses. By this means, an alternating current in the transmission line can make the current flow back and forth on the antenna as shown in Figs. 10(b) and (c). When a coaxial cable is used, the action is similar: When the current flows up on the center conductor, it flows down on the outer conductor, and vice versa.*

For the antenna to work best, the transmission line should be perpendicular to the axis of the antenna. In other words, the angle between the coaxial cable (or parallel-wire line) and the dipole antenna wire should be 90 degrees at the feed point.

E. Bandwidth

The half-wave dipole antenna shown in Fig. 5 is designed to operate at only one frequency. If the frequency of the transmitter is changed, the wavelength changes also, and then the antenna is no longer $1/2$ wavelength long. This does not matter as long as the transmitter frequency is not changed too far; the frequency of the transmitter can be changed ± 3 percent without causing any adverse effects. If the frequency is changed more than that, various difficulties arise.

*When this current flows, the outer conductor radiates a small signal, in addition to the signal radiated by the dipole itself. The effect of this additional signal is usually negligible, but it may be eliminated, if desired, by using a transformer (called a balun) that converts the unbalanced coaxial signal to the balanced dipole feed.

The frequency over which the transmitter can be varied without the antenna causing trouble is called the bandwidth of the antenna. The bandwidth of a half-wave dipole of the type shown in Fig. 5 is ± 3 percent.

If you send a signal up the coaxial cable that is the wrong frequency for the antenna, the antenna does not accept all of it. It sends some of the signal back down the cable again, toward the transmitter. This may be bad for the cable or bad for the transmitter, and it results in less signal being radiated. If the transmitter is very powerful and if its frequency is far enough away from the antenna design frequency, the radio signal coming back from the antenna combined with the signal going out from the transmitter may burn out the cable or damage the transmitter. When the transmitter is on the wrong frequency, we say the antenna reflects energy back down the coaxial cable. When the transmitter is on the correct frequency, we say the antenna matches the coaxial cable, and all the energy coming up the cable is launched into space in the form of radio waves.

As already stated, each antenna has its own resonant frequency in the same way that a violin string has its resonant frequency. This resonant frequency depends not only on the length of the antenna but on its proximity to nearby metal objects or other wires. Sometimes, when the wind blows, the antenna moves closer or farther away from adjacent conductors, and this changes the resonant frequency slightly. As long as it is not changed more than the antenna bandwidth (± 3 percent), very little harm will be done.

If the antenna does not match the coaxial cable for any reason, it reflects the radio signal back down the cable. The radio signal is an alternating current traveling along the cable in the form of a wave train. The waves going up the cable from the transmitter meet the waves coming down the cable from the antenna and combine so as to form stationary waves on the cable. These waves do not move up or down the cable but remain stationary, or fixed in position like soldiers marking time. They are oscillating, but they are not getting anywhere.

These stationary waves, known as standing waves, produce a high radio-frequency voltage at certain places on the cable and a low voltage at certain other places. Dividing the voltage at a high voltage point by the voltage at a low voltage point gives a number known as the voltage standing wave ratio (VSWR). If there are no standing waves, the VSWR is equal to 1. As a rule, the VSWR on the coaxial cable should not be greater than 2; if it is greater than 2, you know the antenna is reflecting back too much signal. This will not happen if the transmitter is kept on the resonant frequency of the antenna.

It is very important to construct the antenna properly, so that it will not reflect the signal back down the cable, and it is also important (when the antenna is used) to keep the transmitter on the frequency for which the antenna was designed. The table following shows approximately the amount of power lost when the wrong frequency is used, assuming a constant power output of 100 watts from the transmitter, and assuming no readjustment of the transmitter output circuit.

<u>Transmitter Frequency</u>	<u>Power Reflected from Dipole (watts)</u>	<u>VSWR</u>	<u>Power Radiated by Dipole (watts)</u>
F (correct frequency)	0	1:1	100
0.98F or 1.01F	11	2:1	89
0.96F or 1.02F	25	3:1	75
0.94F or 1.04F	36	4:1	64
0.92F or 1.05F	44	5:1	56
0.89F or 1.06F	51	6:1	49
0.87F or 1.07F	56	7:1	44
0.85F or 1.09F	60	8:1	40
0.83F or 1.10F	64	9:1	36
0.81F or 1.11F	67	10:1	33
-- --	77	15:1	23
-- --	82	20:1	18

The dipole will radiate more power than shown in the last column of the table (but not the full 100 watts) if the operator takes the trouble to adjust the transmitter output matching circuit for maximum

power output each time he changes frequency. However, many transmitters do not have the capability of matching into a VSWR of more than 3:1, and thus cannot be adjusted to operate efficiently into a badly mismatched load.

You can think of the antenna as a tuned circuit. When the frequency of the transmitter is below the resonant frequency of the antenna, the antenna appears to be capacitive, as in Fig. 11(a). If the frequency is slightly too high, the antenna appears to be

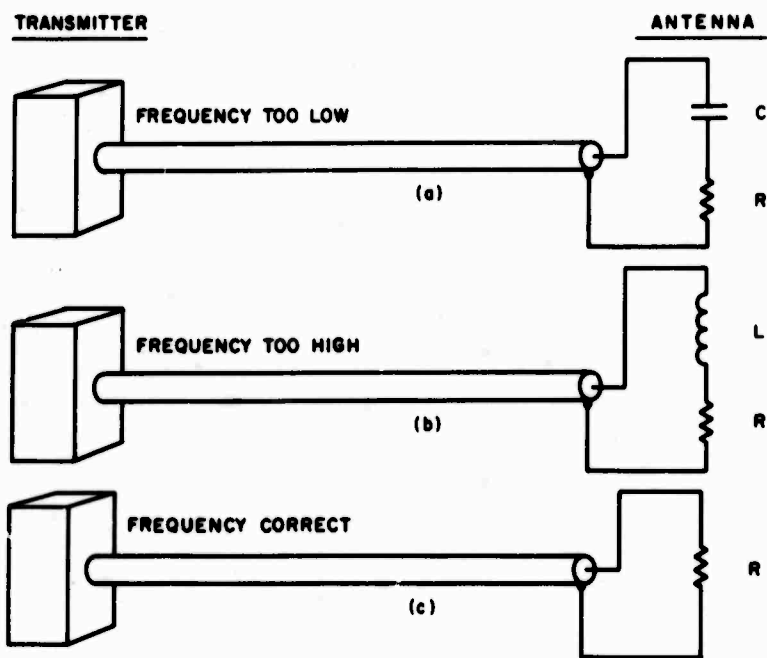

9-6183-11

FIG. 11 EQUIVALENT CIRCUITS FOR ANTENNA BELOW, ABOVE, AND AT RESONANCE

inductive, as in Fig. 11(b). When the transmitter is adjusted exactly to the resonant frequency of the antenna (or vice versa) the antenna appears to be a resistor, as in Fig. 11(c). In the latter case, no signal is reflected back from the antenna, and the VSWR is 1; all the power from the transmitter goes into the antenna. Since there is not a real resistor out at the antenna, there is nothing out there to get hot and use up energy; all the power going into the

antenna is therefore radiated. The imaginary resistor shown in Fig. 11(c) is called the radiation resistance of the antenna. For best results, this radiation resistance should be the same as the characteristic impedance* of the coaxial cable being used. The radiation resistance of the antenna depends on its height above the ground and on the location of the feed point, that is, on whether the coaxial cable is connected in the middle or not. The value of R in Fig. 11(c) can be raised either by putting the antenna up higher above the ground or by moving the feed point away from the center. If the feed point is in the center and the antenna is very high above the ground, the value of R will be about 70 ohms.

Another way to increase the value of R is to use a folded dipole, as shown in Fig. 12. A folded dipole is just like a half-wave dipole (Fig. 5) except that one parallel wire is located about

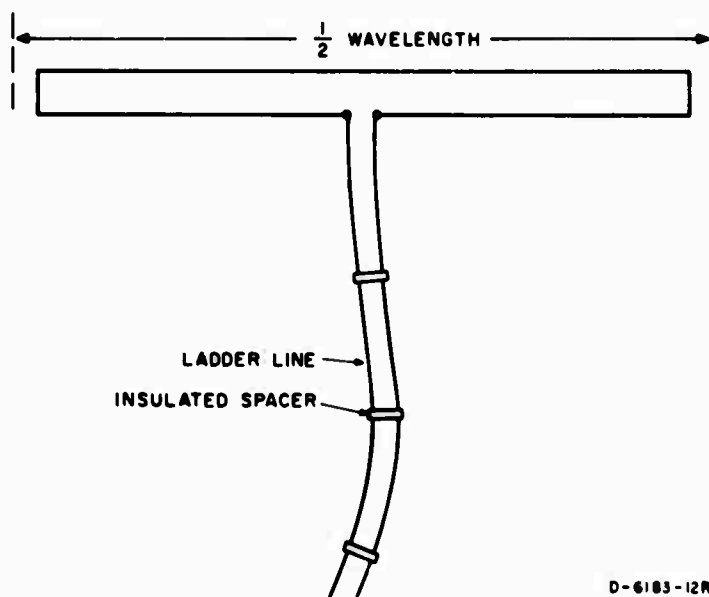

FIG. 12 FOLDED DIPOLE

* Each type of coaxial cable is designed to go with a particular value of resistance; RG-8/U should be terminated in 52 ohms.

15 centimeters (cm) from the original antenna wire. This new wire is connected at each end to the ends of the half-wave dipole. When this is done, the value of R goes up to four times what it was before.

The VSWR on the transmitting cable depends on what is connected at the antenna end. To avoid standing waves, you must meet two requirements: (1) The antenna must "look" like a pure resistance, as in Fig. 11(c), and (2) the value of this resistance must be equal to the characteristic impedance of the cable being used.

It has been mentioned that a half-wave dipole antenna is actually not $1/2$ wavelength long. It turns out that when the length of the antenna is adjusted so that no reflections occur--and there are no standing waves on the cable--the antenna is about 5 percent less than $1/2$ wavelength long. Another way of saying this is that the antennas in Figs. 5 and 12 should be cut to an overall length of approximately 95 percent of $1/2$ wavelength. This is expressed in a formula as follows:

$$L = \frac{95}{100} \times \frac{w}{2} ,$$

where

L = correct overall length for a half-wave dipole antenna

w = operating wavelength.

Example: What should be the overall length of a half-wave dipole antenna designed for operation at 6 Mc/s?

Step 1: Change 6 Mc/s to wavelength.

$$\text{Wavelength} = \frac{300}{6}, \text{ (from page 4)}$$

$$\text{Wavelength} = 50 \text{ meters.}$$

Step 2: Find 95 percent of $1/2$ wavelength.

$$L = \frac{95}{100} \times \frac{50}{2} = \frac{4750}{200}$$

$$L = 23.75 \text{ meters.}$$

Answer: A 6-Mc/s half-wave dipole should be 23.75 meters long. (Each half would be 11.875 meters long.)

Figure 13 is a graph from which you can determine the approximate overall length to make a half-wave dipole antenna to work at various frequencies. You remember that it has been stated that the length of the antenna should be approximately 95 percent of 1/2 wavelength. It is impossible to give an exact formula for the length of a dipole antenna because that depends on the proximity of other wires and conducting materials. Therefore, if a method of measuring the VSWR is available, it should be used; the Appendix gives a method for doing this.

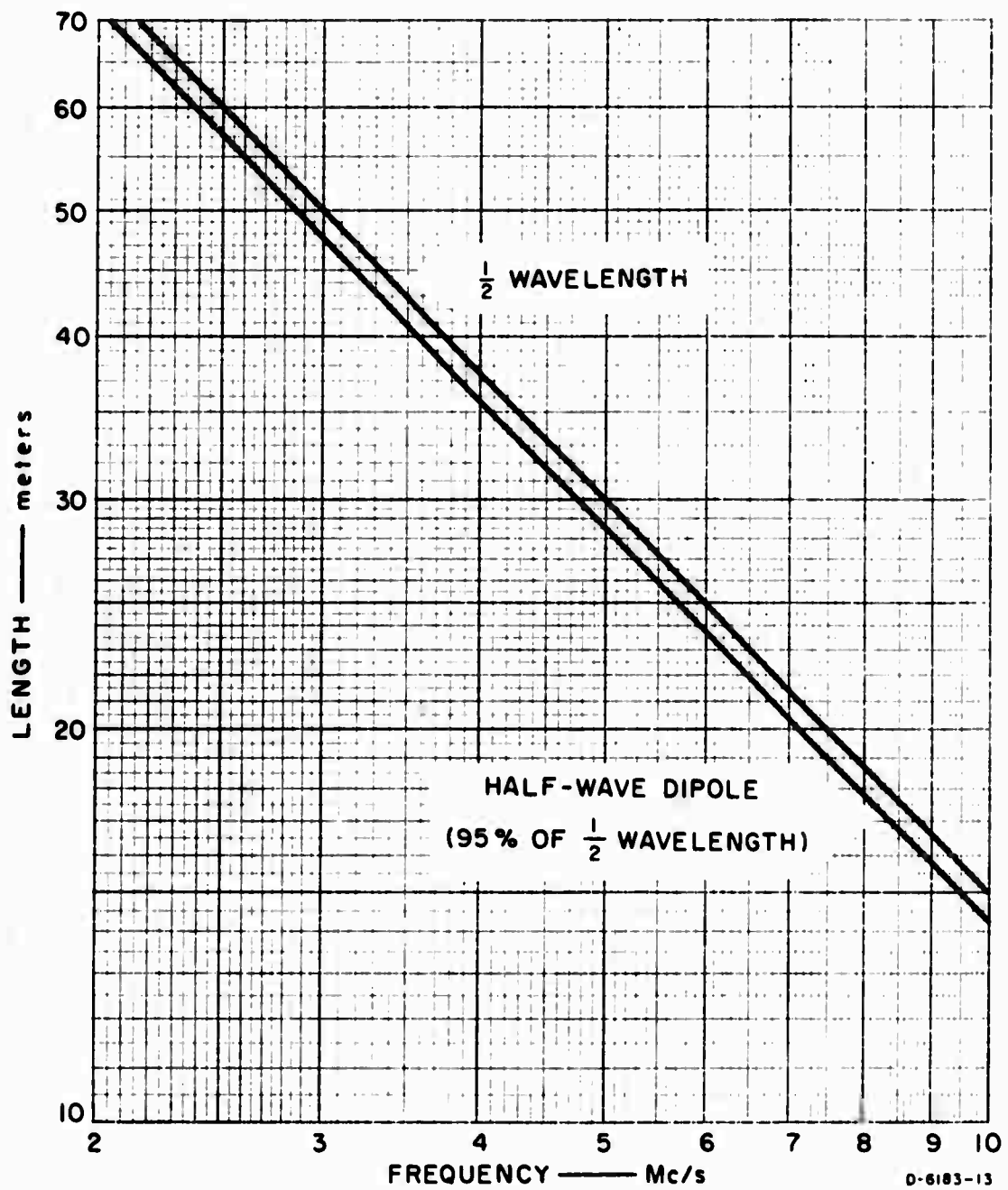

FIG. 13 LENGTH OF HALF-WAVE DIPOLE ANTENNA

III MULTIBAND ANTENNA

A. Description

A sending station is assigned certain frequencies and is normally not allowed to use any others. If separate dipole antennas are used, each one works at only one frequency. The station operator selects the best frequency for the time of day and for the distance to the receiver, and he also selects the correct dipole antenna to go with that frequency. Whenever the operator changes frequencies, he must change antennas as well.

However, some of this antenna switching can be avoided by mounting three dipole antennas together as shown in Fig. 14. All three antennas are connected to the same coaxial cable all the time, which allows the operator to transmit on any one of the three frequencies without changing the cable connections. This is the way it works: The three dipoles are cut to three frequencies that will be used at that station. When the transmitter sends a radio signal up the cable, the antenna designed for that frequency resonates, but the other two antennas reject the signal. Thus most of the current flows in the resonant antenna, and very little signal is reflected back down the coaxial line. The antenna that has the current flowing in it radiates radio waves in the normal manner, while the other two antennas do nothing. If the transmitter sends up a frequency that is not one of the three design frequencies, none of the antennas resonates properly, and there is a reflection of radio signal back down the cable that causes standing waves in the cable.

This type of antenna is called a multiband antenna because it will work at more than one frequency. Since it will actually work over bands of ± 2 percent on each side of the three design frequencies, it is called a multiband antenna rather than a multifrequency antenna.

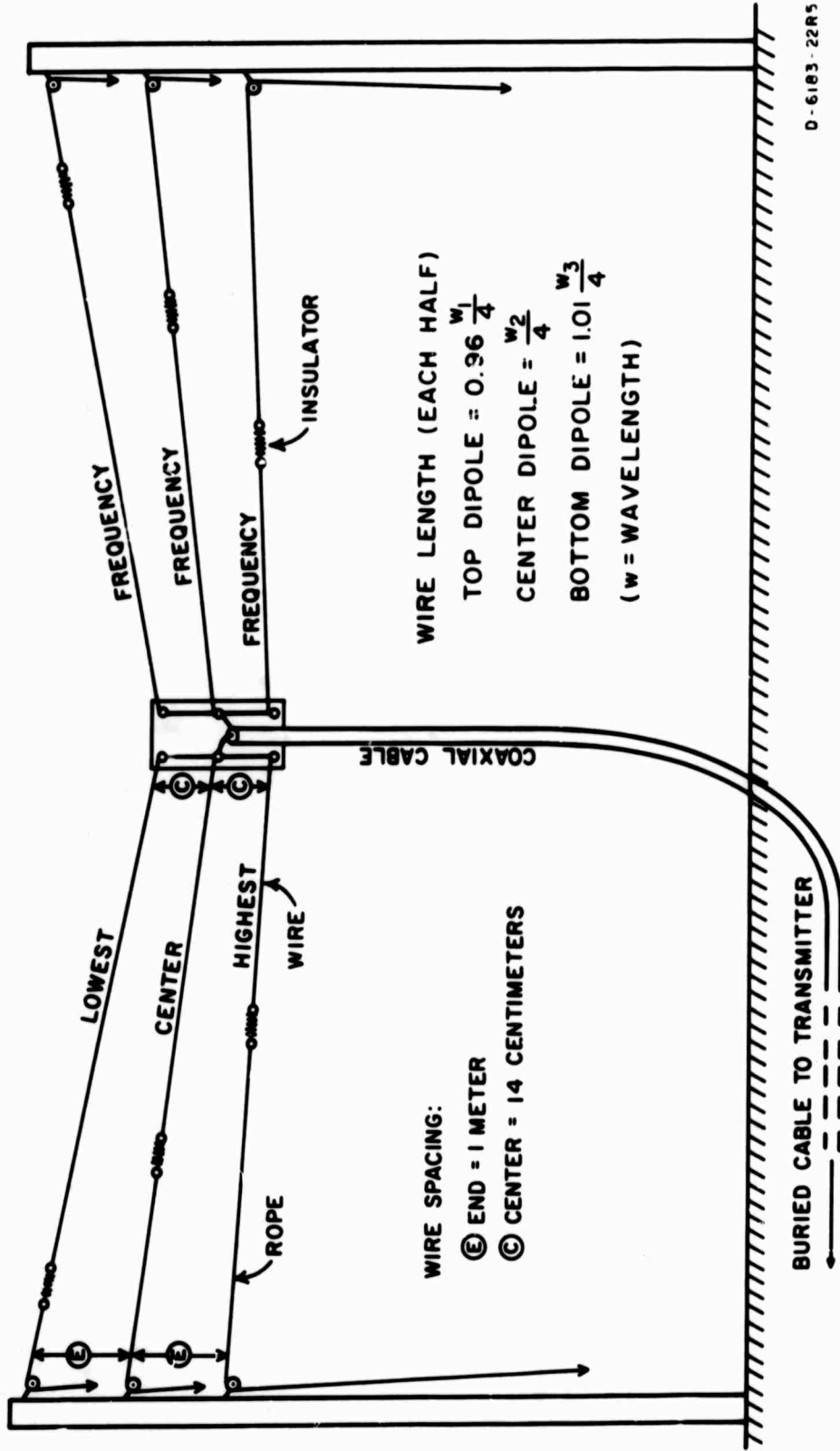

D-6183-22R5

FIG. 14 MULTIBAND ANTENNA

B. Construction

The construction of one type of multiband antenna suitable for three frequencies is shown in Fig. 14. Three wooden antenna poles are put up, each about $1/4$ wavelength high at the highest frequency to be used. (The center pole is not shown in Fig. 14.) Three pulleys are located near the top of each end pole as shown, 1 meter apart. The end poles should be at least 2 meters more than $1/4$ wavelength from the center pole at the lowest operating frequency. The centers of the dipoles are held 14 cm apart by a flat nonconducting board, and are electrically connected in parallel.* The shield (outer conductor) of the coaxial cable is connected to one half of each dipole, and the center conductor is connected to the other half. The longest dipole is placed on top, the shortest on the bottom. All the dipoles lie in the same vertical plane, with the coaxial cable running straight down from the center to the ground, where it is buried about 10 cm underground from the antenna to the transmitter building.

Each dipole consists of two wires, each about $1/4$ wavelength long. The length of the wire is measured from the end insulator to the centerline of the flat board, not including the 14-cm tie line. When cutting the wires, make them too long at first and then trim them down to size later. The exact length may have to be determined by trial and error by measuring the VSWR on the coaxial cable when the transmitter is operating, as explained in the Appendix. If no way of measuring the VSWR is available, each half of the top dipole should be 96 percent of $1/4$ wavelength at the lowest frequency; each half of the center dipole should be exactly $1/4$ wavelength at the center frequency; and each half of the bottom dipole should be 101 percent of $1/4$ wavelength at the highest frequency.

*The wire separation distances given here are not critical, but they should not be less than 14 cm. The wires are separated to reduce mutual coupling, so that when they move with the wind detuning will not occur. The use of a balun is optional, since it does not add materially to the performance.

Nonconducting rope must be used between the insulators and the poles; if this section is made of wire, it will detune the antenna. The ropes must be kept at the right tension so that the spacing between the wires does not change from day to day. To radiate a strong signal, it is necessary to keep the antenna from sagging and to keep the transmitter exactly on one of the three antenna frequencies.

C. Pattern

Each part of the multiband antenna is simply a half-wave dipole, so when it is operating on one of its three resonant frequencies, it has the pattern shown in Fig. 9.

IV SINGLE-WIRE ANTENNA

A. Description

The simplest type of antenna is a wire strung up on poles above the ground, with one end connected to a transmitter. In some situations, this type of antenna is quite satisfactory. It can be used to advantage with transmitting-receiving equipment like the SCR-694 (or the AN/GRC-9) which has one terminal marked ANTENNA and another marked GROUND. The length of the signal wire plus the down lead is made slightly less than one-half wavelength. On a half-wave antenna there is a point of maximum current flow in the center and points of maximum voltage at each end. The radio signal from the transmitter should be fed into the antenna at the end. When the signal is fed into the middle of an antenna, as shown in Fig. 10, we have what is called current feed, and the radiation resistance appears to be about 50 ohms. When the signal is fed into the end of an antenna, we have what is called voltage feed, and the radiation resistance appears to be very high, perhaps 2000 ohms. In one case, the cable supplies high currents to the antenna at the point of current maximum; in the other case, the transmitter supplies high voltage to the antenna at the point of voltage maximum. In either case, the result is the same--the electrons flow back and forth as shown in Figs. 10(b) and (c).

B. Construction

A transmitter designed to operate into a voltage maximum point on the antenna should be connected as shown in Fig. 15. As far as the electrons are concerned, the down lead and the antenna are all one long piece of wire, and they will resonate therein at a frequency depending on the total length. The total length should be 95 percent of $1/2$ wavelength. The antenna will work properly on only one frequency. If the frequency of the transmitter is changed, the length of the antenna must be adjusted accordingly. If this is not done, the full power of the transmitter will not be radiated.

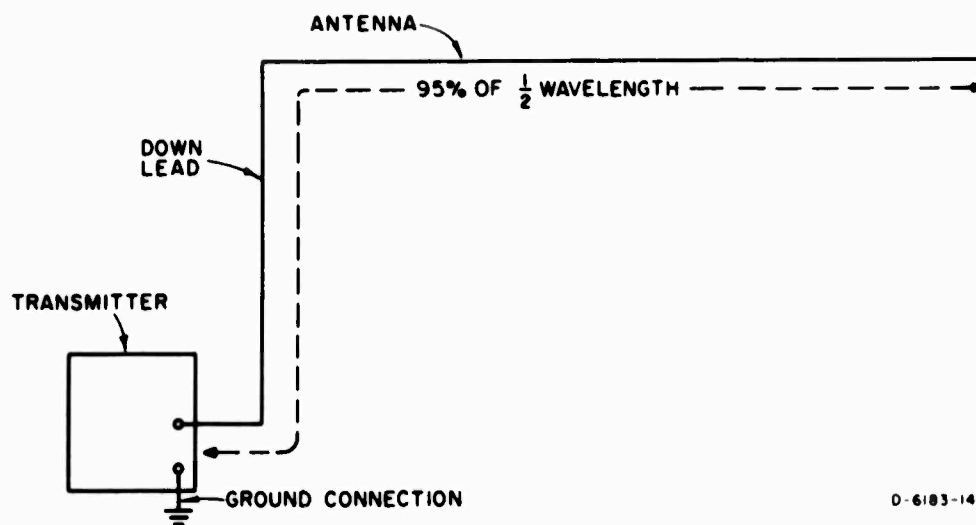

D-6183-14R

FIG. 15 SINGLE-WIRE ANTENNA

All transmitters should be grounded, but it is particularly necessary to ground a transmitter designed to feed power into a single wire, as shown in Fig. 15. The ground connection should be a heavy copper wire from the transmitter to a metal stake or other conducting object buried in damp ground. In locations having a water distribution system, a good ground can be obtained by connecting to a cold water pipe, if this is part of an extensive network of buried piping. If the transmitter is not properly grounded, the operator is likely to receive a radio-frequency burn if he touches it.

Ordinarily, the best policy is to keep the down lead as short as possible and to make the horizontal portion of the antenna as long as possible. A good height for most antennas is $1/10$ to $1/4$ wavelength above the ground.

C. Pattern

The horizontal part of the antenna radiates a pattern similar to that shown in Fig. 9, with horizontal polarization off the sides and vertical polarization off the ends. The down lead radiates a strong signal with an omnidirectional pattern vertically polarized. The total radiation is a summation of these patterns and cannot be predicted easily. In general, however, antennas of this type appear to have better radiation off the sides than off either end, and they may have several deep nulls in the pattern.

For communication between fixed ground stations, where the direction from one station to the other does not change, a satisfactory orientation of the antenna can be found by trial and error. The horizontal part does not have to be exactly horizontal, nor does the down lead have to be vertical, but for optimum power output the total length must be 95 percent of $1/2$ wavelength.

BLANK PAGE

Appendix

INSTALLATION AND OPERATION OF ANTENNAS AND EQUIPMENT

This Appendix gives specific instructions for field radio maintenance and operating personnel. These instructions are based on situations encountered at Communications Centers and typical outpost stations by a field survey team.

1. Pole Locations

The transmitting antennas will be multi-element dipoles as shown in Fig. 14. Most of the antennas will have three elements, each tied at the center to a common feed point, giving the appearance of a fan.

All the receiving antennas will be single-element dipoles cut for operation at 9.5 Mc/s. This makes them 15 meters long.

At each location the antennas will require three poles for the transmitting antenna and one for the receiving antenna, as shown in Fig. A-1. The transmitting antenna will be located so that the center pole is fairly close to the radio room. The poles should be

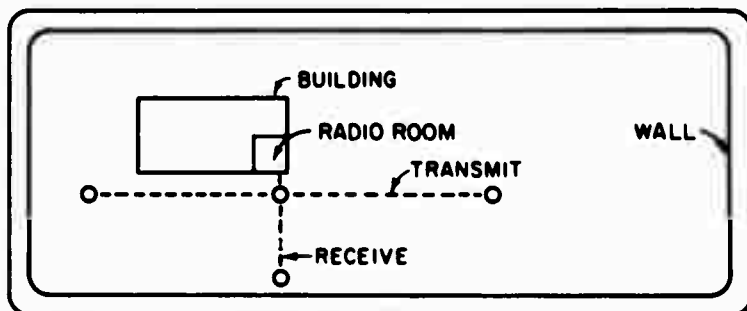

FIG. A-1 EXAMPLE OF ANTENNA POLE SITING

10 meters long, or longer, with 15 percent of this placed in the ground; spacing between poles must be at least 2 meters more than $1/4$ wavelength at the lowest operating frequency. Attached to the top of each end pole will be three pulleys for the antenna halyards. The center pole will have one pulley for supporting the center of

the transmitting antenna and another pulley for the end of the receiving antenna if it is attached there. If it is more convenient, the receiving antenna can be attached to one of the end poles and run perpendicular to the transmitting antenna.

The pulleys should be attached and the ropes strung through them before the poles are erected. The top pulleys are located 1/4 meter from the top, and the lower pulleys are spaced 1 meter apart. The minimum lengths for ropes on one pole are:

<u>Location</u>	<u>Frequency</u>	<u>Rope Length (meters)</u>
End pole, top pulley	Low	22
End pole, center pulley	Medium	24
End pole, bottom pulley	High	35
Center pole, each pulley	--	20
Receiving antenna pole	--	20

When the poles are set, and before the holes are filled, the poles must be rotated so the end-pole pulleys face inward. The center-pole pulleys face to the side.

2. Hanging the Multiband Antenna

Tie the rope from the center pole to the insulating board at the center of the transmitting antenna. Hoist the center of the antenna first, on the center pole, being careful to keep the antenna wires from tangling, and letting out coaxial cable at the same time. When the antenna has been hoisted, secure the rope to a spike near the base of the pole. Taking the halyards from the tops of each end pole, tie them to the longest (lowest frequency) antenna wire insulators; hoist the wire with even tension in both directions; and secure the halyards to the spikes at the base of the poles. Next, using the center pulleys, hoist the medium-length or center antenna, being careful to keep even tension in both directions. Finally, into the lowest or bottom position, hoist the shortest, or highest-frequency antenna wire. If necessary, readjust the tension of the ropes so as to make the wires equally spaced.

Now run RG-8A/U coaxial cable from the center pole to the building. Either bury it in a stone trough or hang it with a supporting cable between the pole and the building at a height of 3 meters or more. Supporting cable will not be required if the distance from the pole to the building is 5 meters or less.

Bring the cable inside to the transmitter; cut it to length; and attach a PL-259 coaxial connector to the cable, in accordance with the assembly instructions provided. The coaxial cable between the antenna feed point and the transmitter should be continuous and unbroken, with no splices.

3. Receiving Antenna

The method of putting up the receiving antenna is the same as that for the transmitting antenna except:

- (1) Type RG-58C/U coaxial cable can be used instead of RG-8A/U.
- (2) The antenna will be a single wire (see Fig. 5) with each side cut to 7-1/2 meters, instead of the multi-wire configuration of the transmitting antenna.

Placement of the antenna is as follows: One of the transmitter poles is used for one end of the receiving antenna. The axis of the receiving antenna is 90 degrees (perpendicular) to that of the transmitting antenna. The coaxial feed line goes straight down to the ground and then into the building.

4. Grounding Equipment

Everybody must understand the importance of grounding the radio equipment. This is a necessity to protect the lives of the operator and the maintenance personnel. Ground is at zero potential (no voltage), and ungrounded equipment is usually at some ac potential above ground. Your body can conduct electricity. If you make a connection with your body between a piece of ungrounded equipment and the ground, electricity may flow through you. When you touch the equipment (especially if you are standing on a damp or wet floor) you will often be able to feel in your body the difference of potential

(voltage) between the equipment and the ground. If you happen to make a good connection a high current may flow, possibly enough to kill you. However, if the equipment is already connected to ground with a good conductor, there will be no potential difference and no current will pass through you. It will go through the ground connection instead.

Not only the transmitter at each station must be grounded but also the radio receiver, control unit, transformer, and metal table must be grounded to a common point. This common point should be a metal rod not less than 1-1/2 meters long driven into the ground through the floor, if possible. Part of the rod should be left extending above the floor for connection of ground wires of future equipment. The wire length from any piece of equipment to the ground rod should not exceed 2 meters. The ground wire should be heavy gauge and soldered if it has been spliced. Individual wires, each with its own ground clamp, should be used from each equipment to the ground rod. Do not connect the equipment in series along the ground line. This can cause excess hum in the transmitter modulation and on the receiver. Grounding should be connected to the main frame of the transmitter (not to a rubber shock mount, which seems to be commonly used).

5. Safety

In a few instances, some of the safety interlock switches at transmitting stations have been "jumpered" (electrically bypassed) at access doors to the BC-610 tuning units and power amplifier tank coils. This is dangerous practice because it removes a safety feature that was built into the transmitter to protect the life of the operator. For example, when the operator is changing a tank coil, he turns the plate power switch off, opens the door and, assuming the plate power is off, reaches in to change the coil. When working with high voltages such as in the BC-610, there should be no assumptions. One must be sure, because his life depends on it. If the interlock switch has been jumpered and if the plate power switch happens to be short-circuited, thus keeping the power on even

after the switch has been turned off, the operator may come into contact with 2500 volts dc, and he may be killed. He is also likely to be killed, of course, if he forgets to turn off the plate power switch.

It is also possible to be electrocuted when all the interlocks are working properly, with all the power turned off. For example, take the case where the bleeder resistor of the high-voltage power supply is open or burnt out. Normally, when the operator turns the plate power switch off, he removes power from the plate transformer and the high-voltage rectifiers. The high-voltage filter capacitors discharge through the bleeder resistor in a short time. When this happens, it is safe to reach in and touch the coil after the power is turned off. However, if the bleeder resistor is broken, there is no discharge path to the ground, and the high-voltage filter capacitors remain charged to a high voltage, +2500 volts in this case, for an indefinite length of time after the power has been turned off. The charge on these capacitors can kill you just as fast as when the power is turned on.

Each transmitting station is equipped with a grounding stick, or if not, each should have one. This stick, made of nonconducting material, is equipped with a metal cap attached to a length of grounding wire. The end of this grounding wire should be permanently connected to the transmitter main frame. Do not use a clip for this connection, because it might come loose. A permanent attachment assures you of a good ground connection and at the same time keeps the stick from straying from the transmitter.

Each time the access door to the power amplifier tank coil is opened, and before the operator reaches in to change the coil, the stick should be used to ground the plates of the power amplifier tuning capacitor. This assures you that no voltage will be left on any component when you reach in.

6. Voltage-Standing-Wave-Ratio Bridge

This is a handy, compact device for checking the transmitter operation at a radio transmitting station. For VSWR measurements, it uses the bridge method of comparing the power supplied to the antenna with that reflected from the antenna. The operation is simple, and accurate matching of the antenna to the transmitter can be done quickly. The VSWR bridge is used at sites where a coaxial cable connects the transmitter to a dipole. It cannot be used with a long-wire antenna. The procedure is as follows:

- (1) Turn the transmitter off. Disconnect the antenna coaxial cable at the transmitter output.
- (2) Connect the bridge INPUT connector to the transmitter output and the ANTENNA connector to the cable. A short cable equipped with male connectors on both ends will be required between the transmitter and bridge.
- (3) Set the switch to the FORWARD position, and rotate the adjusting knob to near minimum position (counter-clockwise).
- (4) Turn the transmitter on, and rotate the adjusting knob for full meter swing.
- (5) Set the switch to the REFLECTED position. Read the VSWR from the meter scale.

A perfect match (1:1 ratio) is ideal and is theoretically possible. Adjustments on the transmitter and antenna should be made so that the VSWR is as low as possible. A VSWR of 2:1 is considered satisfactory; one of 3:1 is acceptable. Anything greater than 3:1 is not acceptable and can result in damage to the transmitter.

The VSWR bridge can also be used for another purpose: to monitor the transmitter output power continuously. To do this, set the switch to the FORWARD position and adjust the knob for a meter swing to about midscale with the transmitter "on." Abnormal variations of the transmitting system will then be indicated by the meter. The instrument consumes practically no power when used in this manner.

7. Antenna Tuning Procedure

The method of antenna adjustment described here requires the use of an indicator like the one described in Sec. 6 above to show the VSWR in the cable leading from the transmitter to the antenna. This method can be used for both the half-wave dipole and the multi-band antenna.

All the wires of a multiband antenna affect each other, but the top wire is the most independent of the three. Therefore, when you adjust a multiband antenna, adjust the top dipole first, then the second, and then the bottom one. Repeat the adjustment again if necessary, in the same sequence.

It is not necessary to put the antenna up and down a great many times, each time clipping it a little bit shorter until you get it right. On the contrary, the proper way to adjust a single-dipole antenna is to put it up once and measure the VSWR; take it down, adjust it to the right length, and put it up a second time for a VSWR check; take it down, cut off excess wire, and put it up for the third and last time. This is accomplished in the following steps:

(1) Put up the antenna for a frequency check.

Put the feed point in the center, so that each half will be equal. Determine the assigned station frequency, and make each half about $1/4$ wavelength long. Make the wires slightly too long, so they can be cut shorter later. To be too long, the wires for a single dipole and for the top element of a multiband antenna should be $1/4$ wavelength, and the wires for the center and bottom elements of the multiband antenna should be about 20 cm longer than $1/4$ wavelength.

(2) Calculate the amount to cut off.

Measure the VSWR in the cable, and adjust the frequency of the transmitter for minimum VSWR. This should turn out to be lower than the station frequency if you have made the trial antenna correctly. Measure the frequency of the transmitter when it is adjusted so as to give the lowest VSWR obtainable. This will be the resonant frequency of the antenna you have made; we will call this the measured frequency. The amount of wire to cut off is found from the following:

Rule--To increase the resonant frequency of a dipole by a small percent, shorten its length by the same percent, and vice versa.

In other words, if the measured frequency of your dipole is 3 percent below the station frequency, the dipole is too long, and its length should be decreased by 3 percent.

Another way to find the amount to cut off is to use the graph in Fig. A-2. This graph shows how much to remove from each half of a dipole to make the resonant frequency rise by a small amount. The frequency change is called delta f (Δf) and is plotted along the bottom of the graph. The amount to cut off to make the frequency rise is called delta l (Δl) and is plotted vertically. The first step in using this graph is to draw a straight diagonal line representing your station frequency between the lines shown on the graph. The location of this line may be estimated visually. Use this station-frequency line when adjusting an antenna for that frequency.

If the resonant frequency of the antenna is too high, by an amount Δf , each half of the antenna must be lengthened by an amount Δl as read from the graph. If the resonant frequency is too low, each half must be shortened.

(3) Shorten the antenna.

Do not cut off the extra wire at first. Make each half of the dipole shorter by folding the wire back on itself, with the extra piece wrapped loosely around the main part. This allows you to make it longer again in case you go too far. This is important when adjusting the multiband antenna, because an adjustment of one dipole may detune the next one.

(4) Make the final VSWR check.

Pull the antenna up into position, and tune the transmitter for the frequency that gives the lowest VSWR. This should be equal to the station frequency. If it is, lower the antenna, cut off excess wire, and make tight wire-wrap connection at the insulator. If the frequency for the minimum VSWR does not come out on the assigned station frequency, go back to Step (2).

The VSWR should be 2:1 or less when the transmitter is tuned for minimum VSWR. If it is not possible to get the VSWR as low as 2:1, it is because the

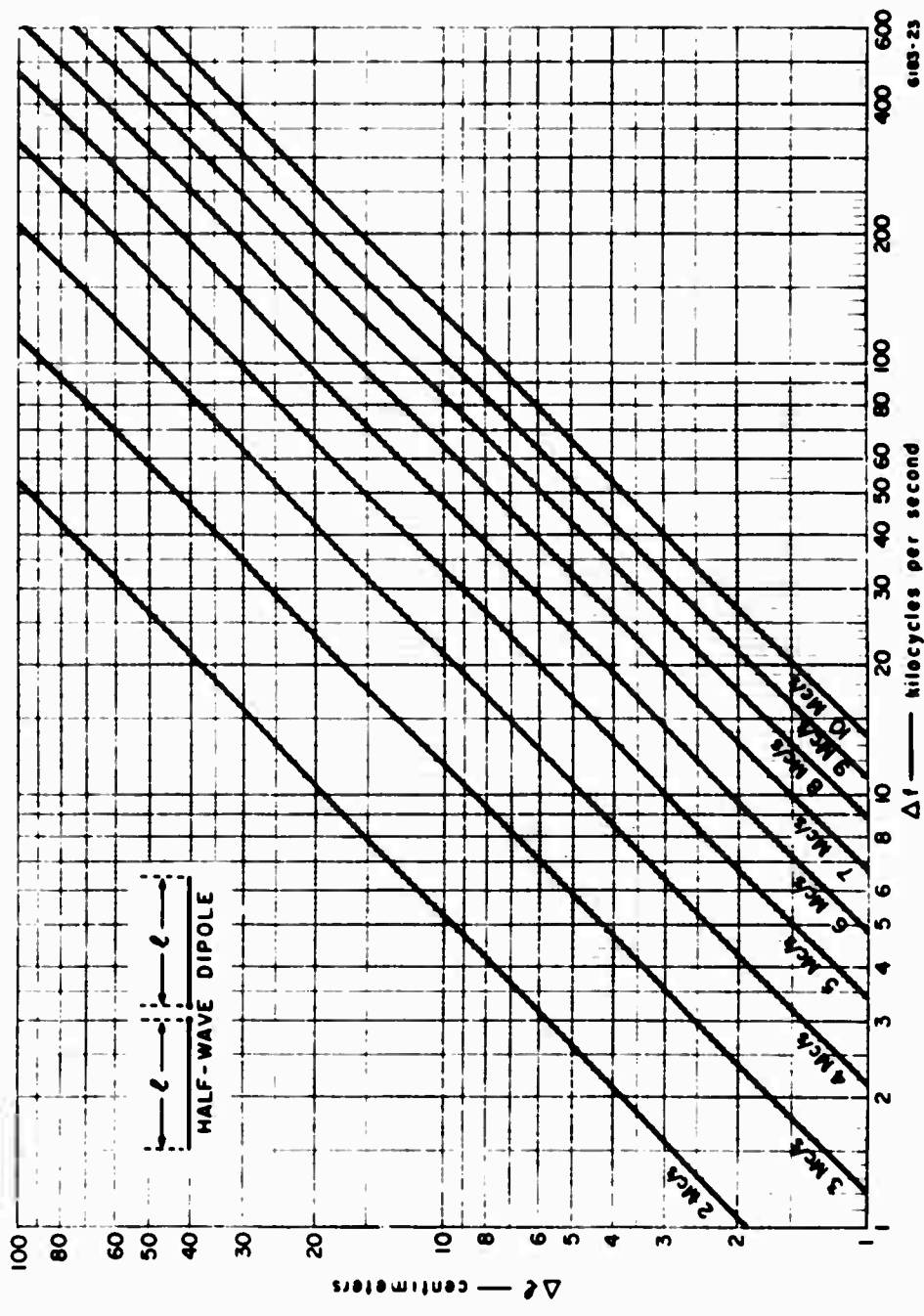

FIG. A-2 DIPOLE ADJUSTMENT REQUIRED TO CHANGE RESONANT FREQUENCY

radiation resistance-- R in Fig. 11(c)--is not equal to the characteristic impedance of the transmission line. Raising or lowering the dipole will change the radiation resistance and may decrease the VSWR. When a half-wave dipole is $1/5$ wavelength above the ground, its radiation resistance is about 52 ohms, which is the correct value to use with RG-8/U cable. A folded dipole (Fig. 12) has a resistance four times as high as a single dipole and should not be used with RG-8/U cable.

8. Field Strength Meter

One method for tuning the AN/GRC-9 is to use a field strength meter, which can be constructed with very few parts. The principle by which it operates is simple. The field strength unit is placed near the transmitting antenna, or near the down lead, where it can pick up some of the energy being radiated. The amount that it picks up is indicated on a meter. The transmitter is then adjusted for a maximum indication on this meter.

The field strength unit is equipped with a short antenna (25 to 50 cm long) which receives radio signals from the transmitting antenna. These signals are rectified and filtered and then operate a dc meter. A schematic diagram of a field strength meter is shown in Fig. A-3. The rectifiers are crystal diodes; selenium diodes cannot be used because of their limited frequency capability.

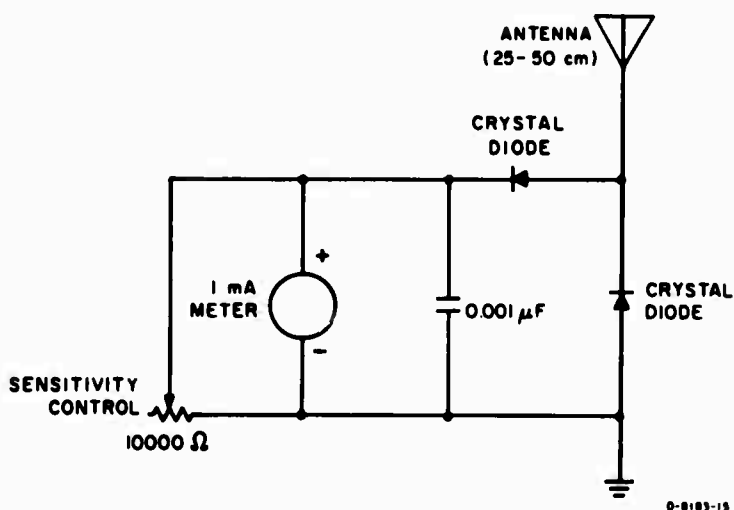

FIG. A-3 FIELD STRENGTH INDICATOR

This field strength meter gives a better indication of the correct or maximum loading of the AN/GRC-9 than the neon bulb on the unit does.

9. Correct Wire Splice

This is the type of splice used for joining two pieces of wire where strength and good conductivity of the wire are required, such as in ground wires, power wires, and antennas, if it becomes necessary to lengthen the wire.

A splice should be soldered, although this is not necessary if the splice is tightly wound and the environment is free from excessive humidity. For reliability it should be soldered; it will then give no further trouble. Before any two wires can be soldered, the surfaces of the metal must be clean and free from any dirt, tarnish, grease, or insulation. Clean the wire by using sandpaper or emery paper or by scraping it with a knife. Do not use a file because it may cut too deeply and weaken the wire. Clean the wire all the way around, for approximately 20 cm from the end.

Before a solder connection can be made, there must be a good strong mechanical connection between the two wires. Solder provides a good electrical connection but will not support any tension or stress. The correct wire splice is a good strong mechanical connection.

When the wire has been cleaned, bend each wire 90 degrees at a point 15 cm from the end [see Fig. A-4(a)]. Be careful not to nick the wire with the pliers. Nicks weaken the wire considerably and cause it to break at the slightest bending. Place the bends of the two wires next to each other as shown in Fig. A-4(b) and hold with a pair of pliers. Twist one wire, as shown in Fig. A-4(c), around the other wire. Three twists are sufficient for heavy wire. More twists are required for smaller wire. Twist the other wire in the same manner. The completed splice should appear as in Fig. A-4(d).

Figure A-5 shows a splice that should not be used, because it is not strong.

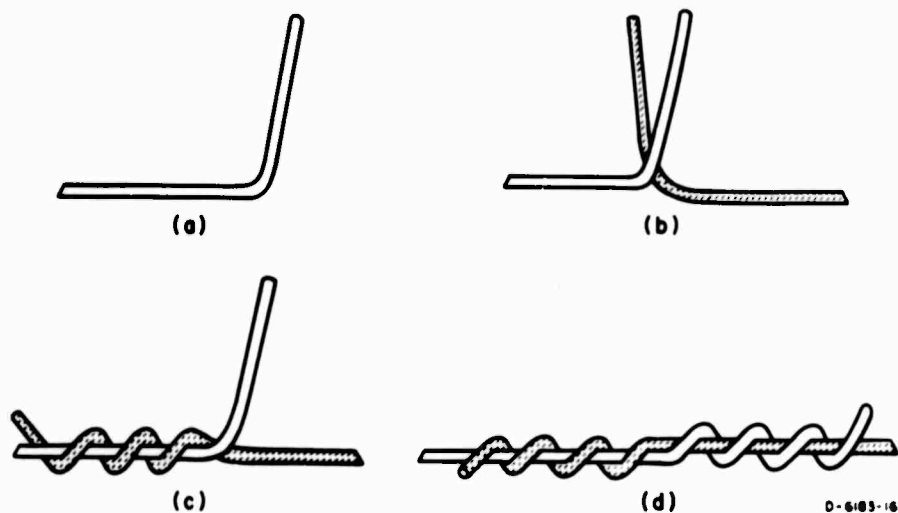

FIG. A-4 CORRECT WIRE SPLICE

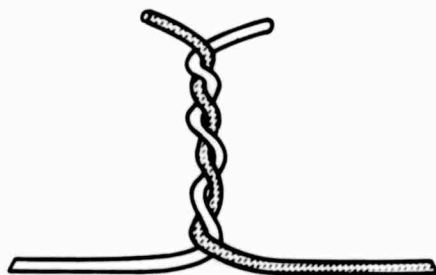

FIG. A-5 INCORRECT WIRE SPLICE

The correct wire splice should be soldered on both ends. Use a good solder and a rosin core flux. Do not use acid core solder. Apply only enough solder to provide a good connection; too much solder is unnecessary and wasteful.

10. Power Cable Splice

Occasionally, it is necessary to splice power cables. Carefully slit the outer insulation all the way around at a point 20 cm from the end of one cable. Use a sharp knife and be careful not to cut the insulation of the inside wires. Carefully slit the insulation lengthwise from the first slit to the end of the wire. With a pair of pliers, grasp the insulation near the slit around the cable, and pull the insulation away. Cut the fiber filler cords from the cable. Strip the insulation from the other cable in the same manner.

Cut the exposed wires of each cable so that one wire is half the length of the other. (On one cable, cut the black wire so that it is only half as long as the white. On the other cable, cut the white wire so that it is only half as long as the black.) Strip the inner insulation from each wire of each cable approximately 5 cm back and clean the exposed wires. Using the correct wire splice, Fig. A-4, connect the black wire of one cable to the black wire of the other cable, and splice the white wires in the same manner. The completed cable splice should appear as in Fig. A-6 with the splices offset as shown. Solder each splice, and tape it with insulating tape.

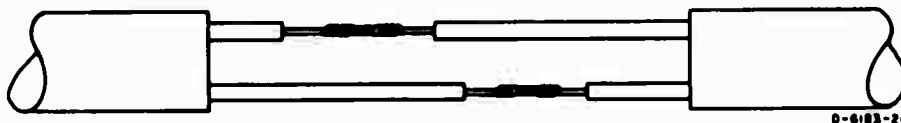

FIG. A-6 POWER CABLE SPLICE

11. BC-610 Modification

Old model BC-610 transmitters have no coaxial connector for the output. The maintenance technician must install this [see Fig. A-7(a)]. It is located in the center of the unit and below the antenna output insulators. The antenna output terminals are connected to the coaxial connector. One terminal is connected to the center pin of the coaxial connector and the other to its flange.

12. Coaxial Cable Adapter Fabrication

It is possible to use the AN/GRC-9 with a half-wave dipole fed by coaxial cable or as a back-up transmitter for the BC-610. (This does not apply to the BC-1306/SCR-694.) Do not cut the cable connector (PL-259) from the coaxial cable, and do not break the coaxial cable to fabricate an antenna patch panel using ac wall-plug connectors. This is not an acceptable way to connect coaxial cable, and any station having this type of connection must remove it. As stated before, the coaxial cable must be one continuous, unbroken, unspliced piece from the antenna to the transmitter.

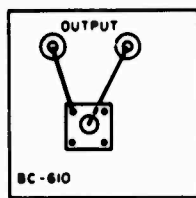

(a)

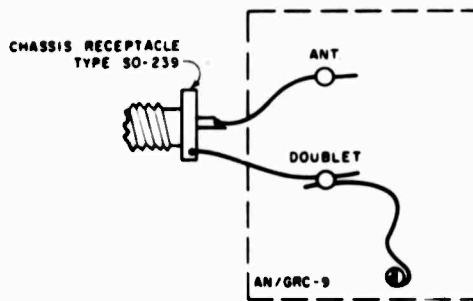

(b)

FIG. A-7 COAXIAL CABLE ADAPTERS

At stations using a back-up transmitter AN/GRC-9 for the BC-610, it will be necessary to make an adapter for the coaxial cable. Use a coaxial chassis receptacle Type SO-239. Solder a short wire to the center pin and another short wire to the mounting flange [see Fig. A-7(b)]. The center pin will then be connected to the ANT (antenna) terminal, and the mounting flange will be connected to the DOUBLET terminal. The DOUBLET terminal is also connected to a chassis ground with a piece of wire not more than 10 cm long. The coaxial cable connector is screwed onto this adapter. The transmitter is loaded into this antenna by using the loading control and the neon lamp or field strength meter as an indicator.

13. AN/GRC-9 and SCR-694 Radio Set Antennas

The antenna most commonly used for the AN/GRC-9 and SCR-694 radio sets is the long wire (refer to Fig. 15). At some locations inspected, the antenna was supported by telephone wire attached to a metal pole. Using a telephone line instead of a rope is not an acceptable practice, because the wire can absorb the radio-frequency energy radiated from the antenna. This energy is either reradiated or dissipated in heat; the antenna may be detuned; and the radiation pattern may be distorted.

Long-wire antennas should be $1/10$ to $1/4$ wavelength high and $1/2$ wavelength long and be located as far from buildings and trees as possible.

Whenever possible, the down lead from the antenna should be one piece of wire unbroken or unspliced, connected to the feed end of the antenna and soldered. If the down lead must be spliced at any point or if the antenna must be spliced, the splice should be made as shown in Fig. A-4(d).

The routing between the antenna and the radio transmitter AN/GRC-9 or SCR-694 should be kept clear of telephone and power wires. If it is necessary to run the feed line close to the building for a short distance, it should be kept no less than 15 cm away from the building.

Where the feed line enters the building, the area should be clear of telephone lines and window screens. If a permanent screen is installed in the building window, a circular hole should be cut in it, 30 cm in diameter; some insulating material should be installed to cover the hole in the screen; and the feed line should be run through the center of the insulation. For insulating material, bakelite is preferable, but in areas that are dry the year round, wood is acceptable, providing the down lead is insulated.

The preferred method for a window with glass panes is to remove one of the panes and replace it with a piece of wood or bakelite. If there are no windows in the building, a hole 20 cm in diameter should be chopped in the wall and the wire supported in the center.

The AN/GRC-9 and SCR-694 should be grounded as described on p. 37, Sec. 4, Grounding Equipment.

DOCUMENT CONTROL DATA - R & D

(Security classification of title, body of abstract and indexing annotation must be entered when the overall report is classified)

1. ORIGINATING ACTIVITY (Corporate author) Stanford Research Institute Menlo Park, California		2a. REPORT SECURITY CLASSIFICATION Unclassified	
		2b. GROUP N/A	
3. REPORT TITLE A FIELD GUIDE TO SIMPLE HF DIPOLES			
4. DESCRIPTIVE NOTES (Type of report and inclusive dates) Instruction Booklet - March 1967			
5. AUTHOR(S) (First name, middle initial, last name) Cecil Barnes, John A. Hudick, and Maurice E. Mills			
6. REPORT DATE March 1967		7a. TOTAL NO. OF PAGES 55	7b. NO OF REFS None
8a. CONTRACT OR GRANT NO. DA-28-043 AMC-02201(E)		9a. ORIGINATOR'S REPORT NUMBER(S) SRI Project 6183	
b. PROJECT NO.		9b. OTHER REPORT NO(S) (Any other numbers that may be assigned this report)	
c.			
d.			
10. DISTRIBUTION STATEMENT Unlimited distribution			
11. SUPPLEMENTARY NOTES		12. SPONSORING MILITARY ACTIVITY Advanced Research Projects Agency Washington, D.C.	
13. ABSTRACT <p>It has been observed that U.S. military and civilian antenna manuals often contain misleading information regarding the construction and operation of HF field antennas. This guide has been prepared to assist in the training of personnel concerned with field communications. It contains instructions on the construction, erection, and use of HF dipole antennas. The simple dipole, folded dipole, and multi-frequency dipole are discussed. Basic Propagation information essential to the understanding of antenna performance is included. (U)</p>			

14

KEY WORDS

LINK A

LINK B

LINK C

ROLE

WT

ROLE

WT

ROLE

WT