



**INNOVATIVE
LIGHTING®**

Our Name. Our Passion. Our Commitment.

WARRANTY INFORMATION



LED (LIGHT EMITTING DIODE) LIMITED LIFETIME WARRANTY:

Innovative Lighting Corporation (ILC) extends a Limited Lifetime LED Lamp Warranty to the original purchaser that ILC's sealed LED Lamp is free from defects in workmanship and/or materials only. Any product developing such defect in material or workmanship within this period will be repaired or replaced with a like product, at our option (ILC) providing it is sent to us, transportation charges prepaid, along with US\$5.00 to cover the cost of handling. Please note; this is not a repair charge. Proof-of-Purchase date to ILC at our Roland, Iowa, factory must accompany return. ILC does not warrant any incandescent electric lamps (bulbs) free against defects and or performance. Excludes ChannelBrite™ and home lighting products.

The LED LIMITED LIFETIME WARRANTY DOES NOT APPLY TO SEVERE APPLICATIONS such as buses, construction equipment and off-road vehicles. These applications are examples only and are not all inclusive of each exclusive application. Many chemicals and/or cleaners are incompatible with ILC's LED products; therefore, the Limited Lifetime Warranty does not apply to damage associated with incompatible chemicals and cleaners. The ILC LED lamps are to remain intact, free from physical abuse, not subject to improper installation or modification. Any violation of these conditions will void this LED Limited Lifetime Lamp Warranty.

This LED Limited Lifetime Warranty is not transferable and applies to the original installation of the sealed LED lamps for as long as the original purchaser owns them.



THREE YEAR LIMITED PRODUCT WARRANTY:

ILC Limited Product Warranty is THREE (3) YEARS on docking lights, horn related products, navigation lights (excluding extend-a-lights and powerlights) Versa-Bryte and their components. Any product developing such defect in material or workmanship within this period will be repaired or replaced with a like product, at our option (ILC) providing it is sent to us, transportation charges prepaid, along with US\$5.00 to cover the cost of handling. Please note; this is not a repair charge. Proof-of-Purchase date to ILC at our Roland, Iowa, factory must accompany return. ILC does not warrant any incandescent electric lamps (bulbs) free against defects and or performance.

This warranty is void if the product warranted has been damaged by accident or unreasonable use, neglect, improper service or other cause not arising out of defects in material or workmanship.



ONE YEAR LIMITED PRODUCT WARRANTY:

ILC Limited Product Warranty is ONE (1) YEAR on all other components, including battery lights, extend-a-light and power light products, trailer lighting and home lighting products. Any product developing such defect in material or workmanship within this period will be repaired or replaced with a like product, at our option (ILC) providing it is sent to us, transportation charges prepaid, along with US\$5.00 to cover the cost of handling. Please note; this is not a repair charge. Proof-of-Purchase date to ILC at our Roland, Iowa, factory must accompany return. ILC does not warrant any incandescent electric lamps (bulbs) free against defects and or performance.

Chrome plated products showing evidence of peeling will be repaired or replaced at ILC's discretion. Chrome showing signs of wear due to debris, rock chips, pitting, etc. will not be covered.

This warranty is void if the product warranted has been damaged by accident or unreasonable use, neglect, improper service or other cause not arising out of defects in material or workmanship.

PRICES:

Prices are subject to change without notice.

TERMS:

Net 30 Days (upon open credit approval).

MINIMUM ORDER:

Orders less than US\$50.00 will be accepted for an additional handling charge of US\$5.00.

FREIGHT POLICY:

FOB Roland, Iowa.

DROP SHIPMENTS:

Drop shipments will be assessed a fee of US\$5.00.

ORDER LEAD TIME:

A minimum of ten (10) working days is requested on all orders. ILC daily cut-off time for shipments is 12:00 PM Central Standard Time. Orders received and requesting same day shipping after 12:00 PM will be processed and shipped the following business day. ILC will try to accommodate all customers requesting same day shipping service.

STANDARD OEM PACKS:

ILC standard packs are shown on the OEM price list. All orders received will be adjusted to the nearest standard pack. A US\$5.00 breakage fee will apply to each item not being adjusted to standard pack quantities.

SHORT SHIPMENTS:

ILC will allow fifteen (15) days from the date of receipt of goods for claims regarding any product shortages.

OUTSTANDING CREDIT:

Customers who returned product for credit must exercise the credit within six (6) months from the date of issuance, otherwise customer will lose credit benefit.

FINANCE CHARGE:

A finance charge of 1.5% per month applies to all late payments.

BILLING:

ILC will allow thirty (30) days from the date of invoice regarding any claims concerning, but not limited to, billing errors, pricing errors, terms, freight reimbursement, and alike examples.

INTERNATIONAL:

A US\$45.00 Documentation / Processing fee applies to all international shipments outside the Continental USA.



MARINE

ACCENT & COURTESY | MARINE | TRUCK & TRAILER | RECREATIONAL VEHICLES | INDUSTRIAL / COMMERCIAL

Marine Lighting Guidelines

Light Positioning Requirements for Vessels Under Power of Less Than 20 Meters (65 Feet) in Length for International and Inland Rules

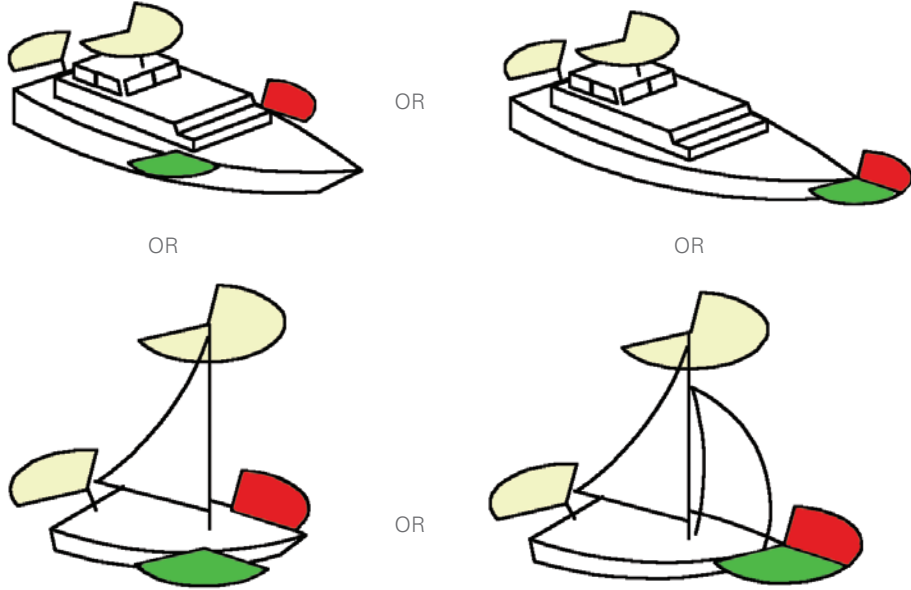

Light Positioning Requirements for Sailing Vessels Under Way International and Inland Rules

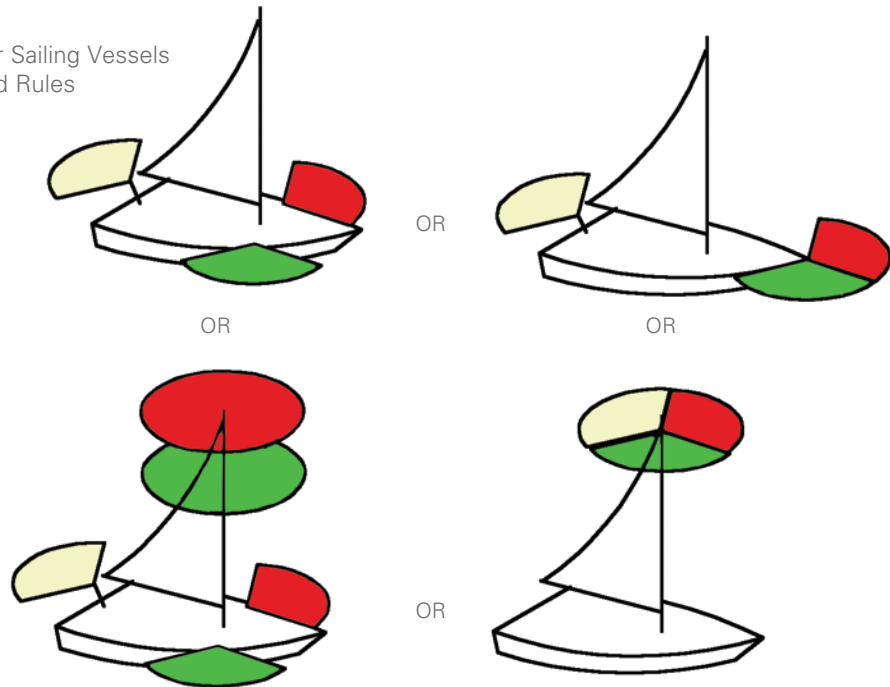

Alternative Light Positioning for Vessels Under Power of Less Than 12 Meters (39 Feet) in Length for International and Inland Rules

Notes: A power driven vessel of less than 12 meters (39 ft.) in length may exhibit an all-round white light and sidelights instead of the masthead light and stern light.

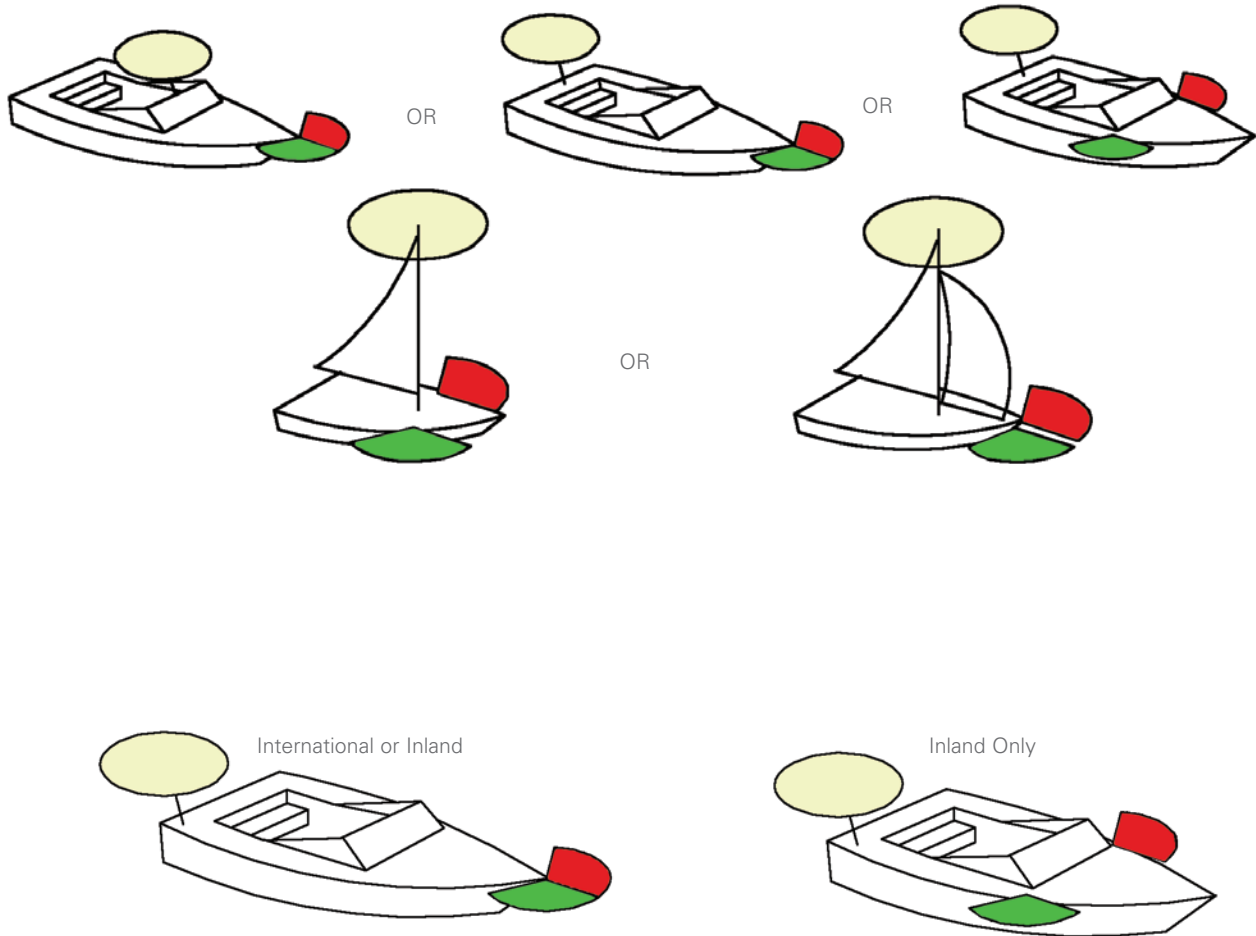

Please note: this is merely a guide to lighting placement. Please refer to any laws in your area for more detailed information.

Extend-A-Light Manual LED Stern Light

Gunnel Depth Required

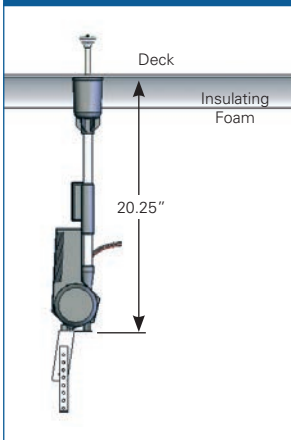

Patent #5304993, #5398026

DETAILS

- Operates 12 Volt DC Systems
- For Powerboats Under 20 Meters (65.6 Ft.)
- Single LED Configuration
- 50,000 Hours LED Service Life
- Energy Draw 180 mA
- Vibration/Shock Proof
- Sealed Circuitry
- Requires 1 3/4" (1.750") Hole
- Corrosion Resistant Construction
- Durable Stainless Steel Telescopic Pole
- Easily Installed on New and Used Boats
- No Change in Current Switch Required
- Certified Ignition Protected
- IMCI Certified for ISO #8846
- Easy Pull-up/Push-down Hand Operation

PRODUCT NUMBERS

514-1200 - 4 Ft. - Chrome Deck Ring

Bulk Std. Pack Qty = 8
Packaged Std. Pack Qty = 1

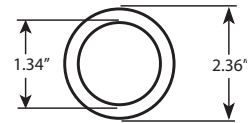

Replacement Parts



504-9900 - Anchor Bracket for PowerLight and Extend-A-Light



514-9900 - Replacement Chrome Deck Ring for Extend-A-Light



504-9915 - Replacement All-round LED Lens

All-Round LED Plug-In Mount Stern Light



DETAILS

- Operates 9-16 Volt DC Systems
- Single LED Configuration
- For Powerboats Under 20 Meters (65.6 ft.)
- Extends from 2 ft. to 6 ft.
- 50,000 Hours of Service Life
- Energy Draw 180 mA
- Shock and Vibration Proof
- Sealed Circuitry
- Easy Pull-Up/Down Hand Operation
- Adjustable Height
- Corrosion Resistant
- Durable Stainless Steel Telescopic Pole
- Easily Installed on New and Used Boats
- No Change in Existing Switch Required
- Certified Ignition Protected
- IMCI Certified for ISO #8846

PRODUCT NUMBERS

512-1210 - LED Stern Light w/ Stainless Steel Rectangular Base
512-1220 - LED Stern Light w/ Stainless Steel Round Base

Bulk Std. Pack Qty = 24
Packaged Std. Pack Qty = 6

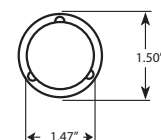
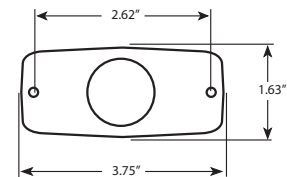

All-Round LED Ski Light Tall Base



DETAILS

- Operates 9-16 Volt DC Systems
- Single LED Configuration
- For Powerboats Under 20 Meters (65.6 ft.)
- 50,000 Hours of Service Life
- Energy Draw 180 mA
- Transparent Lens and Globe
- Shock and Vibration Proof
- Fixed Mounting Base

PRODUCT NUMBERS

503-0000 - Ski Light Tall Base
 Bulk Std. Pack Qty = 24
 Packaged Std. Pack Qty = 6

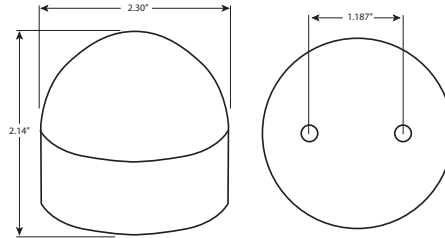

All-Round LED Pedestal Mount Light



DETAILS

- Operates 12 Volt DC Systems
- Single LED Configuration
- For Powerboats Under 20 Meters (65.6 Ft.)
- 50,000 Hours of Service Life
- Energy Draw 180 mA
- Transparent Lens
- Shock and Vibration Proof
- Equipped with Stainless Steel Shaft
- Fixed Mounting Base

PRODUCT NUMBERS

500-0400 - 12" All-round Pedestal Mount
 Bulk Std. Pack Qty = 24
 Packaged Std. Pack Qty = 6

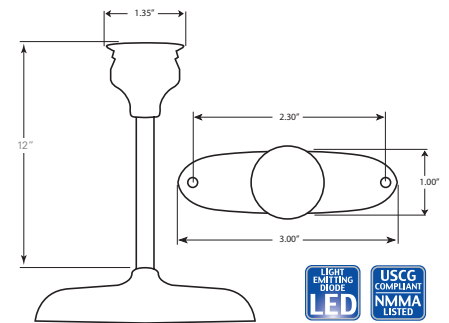

LED Combination Sidelight Deck Mount



DETAILS

- Operates 9-16 Volt DC Systems
- 6 LED Configuration
- For Powerboats Under 20 Meters (65.6 Ft.)
- 50,000 Hours of Service Life
- Requires .375" Hole
- Energy Draw 110 mA
- Transparent Lens
- Cool to the Touch
- Stainless Steel Housing
- Hard Wire Leads
- Available in 12 & 24 volt
- European Approvals Pending

PRODUCT NUMBERS

550-1200 - Polished Stainless Steel
 Bulk Std. Pack Qty = 24
 Packaged Std. Pack Qty = 6

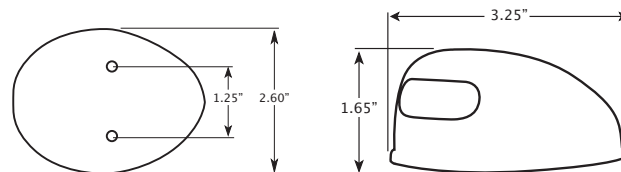

Patent #7,055,995

LED Sidelights Vertical Mount



DETAILS

- Operates 9-16 Volt DC Systems
- 3 LED Configuration
- For Powerboats Under 20 Meters (65.6 Ft.)
- 50,000 Hours of Service Life
- Requires .375" Hole
- Energy Draw 55 mA
- Transparent Lens
- Cool to the Touch
- Stainless Steel Housing
- Hard Wire Leads
- Available in 12 & 24 volt
- European Approvals Pending

PRODUCT NUMBERS

- 554-2100-1 - Starboard Enamel Baked White Stainless Steel
- 554-3100-1 - Port Enamel Baked White Stainless Steel
- 554-2200-1 - Starboard Polished Stainless Steel
- 554-3200-1 - Port Polished Stainless Steel

Bulk Std. Pack Qty = 24
Packaged Std. Pack Qty = 6

- 554-1100-7 - Starboard and Port Enamel Baked White Stainless Steel
- 554-1200-7 - Starboard and Port Polished Stainless Steel

Packaged Only= 1 Pair

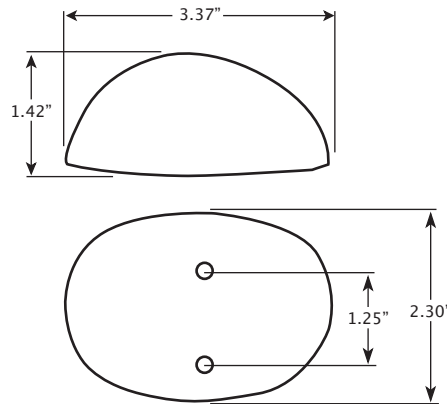

Patent #7,055,995



LED Sidelights Deck Mount



DETAILS

- Operates 9-16 Volt DC Systems
- 3 LED Configuration
- For Powerboats Under 20 Meters (65.6 Ft.)
- 50,000 Hours of Service Life
- Requires .375" Hole
- Energy Draw 55 mA
- Transparent Lens
- Cool to the Touch
- Stainless Steel Housing
- Hard Wire Leads
- Available in 12 & 24 volt
- European Approvals Pending

PRODUCT NUMBERS

- 552-2100-1 - Starboard Enamel Baked White Stainless Steel
- 552-3100-1 - Port Enamel Baked White Stainless Steel
- 552-2200-1 - Starboard Polished Stainless Steel
- 552-3200-1 - Port Polished Stainless Steel

Bulk Std. Pack Qty = 24
Packaged Std. Pack Qty = 6

- 552-1200-7 - Starboard and Port Polished Stainless Steel

Packaged Only = 1 Pair

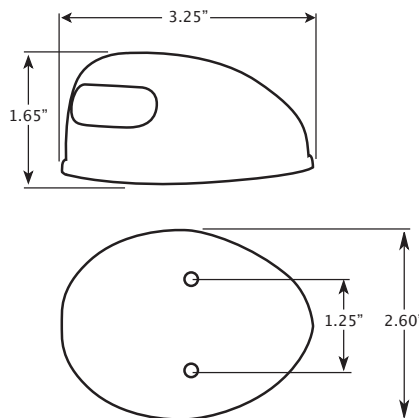

Patent #7,055,995



Marine Portable LED Navigation Light



DETAILS

- Requires 4 "AA" Batteries (Not Included)
- Molded One Piece White Body Construction
- Shock Resistant Neoprene Accents
- Rated at 100,000 Hours LED Service Life
- Uses 90% Less Energy than Incandescent
- Sealed Heavy Duty On/Off Switch
- Insert Molded Brass Threaded Mounting Bushings
- Removable Lamp Carriage Assembly
- 1 LED
- Metal Mounting Hardware

PRODUCT NUMBERS

- 560-1110 - Bow Light w/ Screw On/Off Suction Cup
 - 560-2110 - Stern Light w/ Screw On/Off Suction Cup
 - 560-1111 - Bow Light w/ Universal "C" clamp
 - 560-2113 - Stern Light w/ 18" Pole and Universal "C" and "U" clamp
 - 560-1112 - Bow Light w/ 2" Stud Mount Inflatable Base with attached Lanyard and Stainless Steel "D" Ring
 - 560-2112 - Stern Light w/ 2" Stud Mount Inflatable Base with attached Lanyard and Stainless Steel "D" Ring
- Packaged Std. Pack Qty = 6

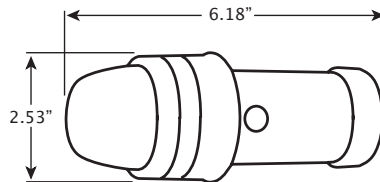

Marine Portable Incandescent Navigation Light



DETAILS

- Requires 4 "AA" Batteries (Not Included)
- Molded One Piece Gray Body Construction
- Shock Resistant Neoprene Accents
- Super-Brite Krypton Lamp
- Sealed Heavy Duty On/Off Switch
- Insert Molded Brass Threaded Mounting Bushings
- Removable Lamp Carriage Assembly
- 1 Krypton bulb
- Metal Mounting Hardware

PRODUCT NUMBERS

- 560-1602 - Bow Light w/ 2" Stud Mount Inflatable Base with attached Lanyard and Stainless Steel "D" Ring

Packaged Std. Pack Qty = 6

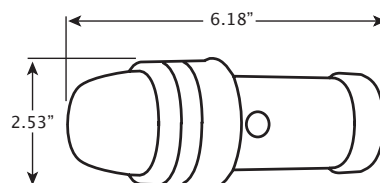

Camouflage Marine Portable LED Navigation Light



- DETAILS
- Requires 4 "AA" Batteries (Not Included)
 - Molded One Piece Body Construction
 - Shock Resistant Neoprene Accents
 - Rated at 100,000 Hours LED Service Life
 - Uses 90% Less Energy than Incandescent
 - Sealed Heavy Duty On/Off Switch
 - Insert Molded Brass Threaded Mounting Bushings
 - Removable Lamp Carriage Assembly
 - 1 LED

PRODUCT NUMBERS
 560-1814 - Bow Light with Universal "C" clamp Camouflage Body
 560-2813 - Stern Light with 18" Pole and Universal "C" and "U" clamp Camouflage Body

Packaged Std. Pack Qty = 6

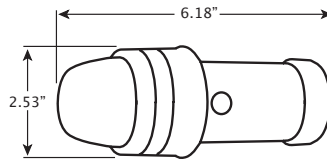

Replacement Parts



Sonic Welded Lenses

- 560-9900 - Replacement Bow Lens Assembly
- 560-9902 - Replacement Stern Lens Assembly
- 560-9901 - Replacement Bow Lens Assembly Camo
- 560-9903 - Replacement Stern Lens Assembly Camo



Aluminum Mounting Brackets

- 560-9905 - Replacement Universal "C" clamp and Mounting Hardware
- 560-9908 - Replacement 18" Pole w/ "U" clamp and Mounting Hardware



Suction and Inflatable Mounts

- 560-9904 - Suction Cup
- 560-9906 - 2" Stud Mount Inflatable Base with attached Lanyard and Stainless Steel "D" Ring
- 560-9907 - Inflatable Pull Pin



Lamps

- 560-9909 - Incandescent Krypton Lamp
- 560-9912 - LED Lamp with Optical Dispersion Lens (To convert Incandescent to LED)



Docking / Hull / Back-up Lights



COLOR OPTIONS



Mirror Black

DETAILS

- Operates 12-Volt DC Systems
- 50-Watt Halogen Lamp
- Draws 4 Amps Each
- Sealed Built-in Rear Heat Sink
- Thermal Insulated Wires
- Pyrex Optical Lens
- Spring Loaded Lamp Assembly
- Removable Lens Cover
- Water Tight Gaskets Included
- Patent #D472,654

PRODUCT NUMBERS

- 580-0200 - Mirror Polished - Pair
- 580-9902 - Replacement Mirror Lens w/ Gasket
- 580-0000 - Enamel Baked Black - Pair
- 580-9900 - Replacement Black Lens w/ Gasket
- 580-9904 - Replacement Bulb

Bulk Std. Pack Qty = 12
Packaged Std. Pack Qty = 1

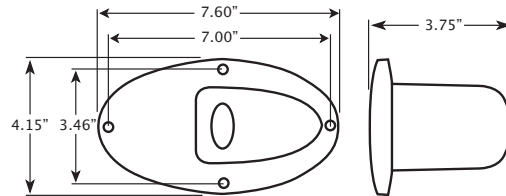

LED Docking Light



DETAILS

- Size: 9.66" L x 4.7" W x 0.95" D
- Rated at 50,000 Hours Service Life
- Shock and Vibration Proof
- Corrosion Resistant and Waterproof
- Front Light utilizes 2 high-power LEDs
- Side Light contains 8 LEDs that are operated independently from front lights
- Light spread of 160 degrees
- Stainless Steel cover and mounting screws
- Installation requires only 1/2" hold for wire leads and 4 pilot holes for mounting screws

PRODUCT NUMBERS

- 585-0210 - Mirror Polished - Pair
- 585-9902 - Replacement Mirror Lens w/ Gasket
- 585-9906 - Replacement Neoprene Gasket for LED Docking Light

Bulk Std. Pack Qty = 6 pr.
Packaged Std. Pack Qty = 1 pr.

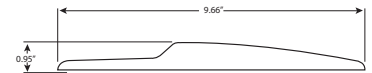
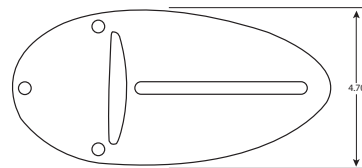

LED Docking Light II



DETAILS

- Size: 7.25" L x 3.75" W x 0.875" D
- Rated at 50,000 Hours Service Life
- Shock and Vibration Proof
- Corrosion Resistant and Waterproof
- Front Light utilizes 2 high-power LEDs
- Side Light contains 8 LEDs that are operated independently from front lights
- Light spread of 160 degrees
- Stainless Steel cover and mounting screws
- Installation requires only 1/2" hold for wire leads and 4 pilot holes for mounting screws

PRODUCT NUMBERS

- 586-0210-4 - Surface Mount LED Docking Light II

Bulk Std. Pack Qty = 6 pr.
Packaged Std. Pack Qty = 1 pr.



Cup Holders - Double Stack Design



DETAILS

- Molded, UV-Resistant Plastic
- Numerous Colors Available
- Available Without or With Large or Small Drain Tubes
- Cup Holder Dims: Overall Diameter: 4"
- Overall Height less drain tube: 3.2"
- Required Hole Size: 3.6" diameter

PRODUCT NUMBERS

- W-DS-ALGYET - Light Gray Double Stack w/ Small Drain Tube
- W-DS-AWTEBT - Arctic White Double Stack w/ Big Drain Tube
- W-DS-AWTET - Arctic White Double Stack w/ Small Drain Tube
- W-DS-BGENT - Beige Double Stack w/o Drain Tube
- W-DS-BGET - Beige Double Stack w/ Small Drain Tube
- W-DS-BKET - Black Double Stack w/ Small Drain Tube
- W-DS-BKET-BC7 - Black Double Stack w/ Small Drain Tube & Bar Code

- W-DS-CHLGYEBT - Light Gray Double Stack w/ Big Drain Tube
- W-DS-CHTNEBT - Tan Double Stack w/ Big Drain Tube
- W-DS-DWSET - Driftwood Double Stack w/ Small Drain Tube
- W-DS-DWTEBT - Dream White Double Stack w/ Big Drain Tube
- W-DS-SGYET - Seal Gray Double Stack w/ Small Drain Tube
- W-DS-WTEBT - White Double Stack w/ Big Drain Tube
- W-DS-WTENT - White Double Stack w/o Drain Tube
- W-DS-WTET - White Double Stack w/ Small Drain Tube
- W-DS-WTET-BC7 - White Double Stack w/ Small Drain Tube & Bar Code
- W-DS-WWTET - Weeres White Double Stack w/ Small Drain Tube



Adjustable Cup Holders



DETAILS

- Molded, UV-Resistant Plastic
- Numerous Colors Available

PRODUCT NUMBERS

- 7-AFD-BKANH - Black Adjustable Fold Down Cup Holder w/ No Hardware
- 7-AFD-BKAZH - Black Adjustable Fold Down Cup Holder w/ Hardware
- 7-AFD-BRANH - Brown Adjustable Fold Down Cup Holder w/ No Hardware
- 7-AFD-BRAZH - Brown Adjustable Fold Down Cup Holder w/ Hardware
- 7-AFD-PWTANH - White Adjustable Fold Down Cup Holder w/ No Hardware
- 7-FD-BKANH - Black Fold Down Cup Holder w/ No Hardware



Grab Handles - Molded, UV-Resistant Grab Handles



DETAILS

- Hard and Soft Grip Versions Available
- Textured for Sure Grip
- Rubberized Ergonomic Feel
- Hidden Stainless Steel Fasteners
- Center to Center of Fasteners Measures 7.5"

PRODUCT NUMBERS

- 7-GH-AWTPHG - Arctic White Grab Handle - Hard Grip Model
- 7-GH-BKRPSG - Black Grab Handle - Soft Grip Model
- 7-GH-CHLGYRPSG - Light Gray Grab Handle - Soft Grip Model
- 7-GH-CHTNRPSG - Tan Grab Handle - Soft Grip Model
- 7-GH-MBRPSG - Moon Beam Grab Handle - Soft Grip Model
- 7-GH-PLRPSG - Pearl Grab Handle - Soft Grip Handle
- 7-GH-SGYPHG - Seal Gray Grab Handle - Hard Grip Model
- 7-GH-WGYPHG - Warm Gray Grab Handle - Hard Grip Model

Patent Pending



Access Plates - Watertight



DETAILS

- Positive "O" Ring Seal on Both Pry-Out and Twist-Out Versions
- Total UV & chemical stability
- Requires no tools for opening

PRODUCT NUMBERS

- W-AP-4AWTPT - Arctic White 4" Access Plate - Twist Out Model w/ O-Ring
- W-AP-4LWTPT - White 4" Access Plate - Twist Out Model w/ O-Ring
- W-AP-5AWTPT - Arctic White 5" Access Plate - Twist Out Model w/ O-Ring
- W-AP-6AWTPT - Arctic White 6" Access Plate - Twist Out Model w/ O-Ring
- W-AP-6AWTTP - Arctic White 6" Access Plate - Pry Out Model w/ O-Ring
- W-AP-6BKTPT - Black 6" Access Plate - Twist Out Model w/ O-Ring
- W-AP-6LBGPP - Beige 6" Access Plate - Pry Out Model w/ O-Ring
- W-AP-6LWTPP - White 6" Access Plate - Pry Out Model w/ O-Ring
- W-AP-8AWTTP - Arctic White 8" Access Plate - Pry Out Model w/ O-Ring
- W-AP-8AWTPT - Arctic White 8" Access Plate - Twist Out Model w/ O-Ring
- W-AP-8LWTPB - White 8" Access Plate - Blank Model
- W-AP-8MSPP - Arctic White 8" Access Plate - Pry Out Model w/ O-Ring



LED Bulkhead / Livewell Recess Mount Light



DETAILS

- Operates 9-16 Volt DC Systems
- Rated at 100,000 Hours of Service Life
- Requires 11/16" (.687) Hole
- Shock and Vibration Proof
- Energy Draw 15-45 mA depending on color
- Cool to the Touch
- Corrosion Resistant

PRODUCT NUMBERS

- 011-1500 - Amber
- 011-2500 - Blue
- 011-3500 - Green
- 011-4500 - Red
- 011-5500 - White

Bulk Std. Pack Qty = 12
Packaged Std. Pack Qty = 6

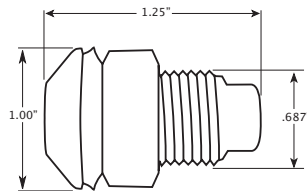

Patent #D439,350



1" Round LED "Shortie" Livewell/Bulkhead Light with 219 Grommet



DETAILS

- Size: 1" dia. x .68" d
- Clear Lens
- Rated for 100,000 hours
- Requires .075" Hole and 0.52" Depth
- Waterproof
- Shock and Vibration Proof
- Single LED Design
- 6.5" 18 AWG Wires
- Operates on 9-16 Volts DC

PRODUCT NUMBERS

- 011-2550 Blue Shortie Livewell
- 011-5550 White Shortie Livewell

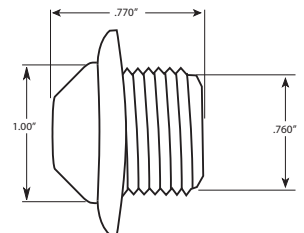

1" Round LED "Shortie" Livewell/Bulkhead Light with Black Grommet



DETAILS

- Size: 1.4" dia. x .68" d
- Clear Lens
- Rated for 100,000 hours
- Requires .075" Hold and 0.52" Depth
- Waterproof
- Shock and Vibration Proof
- Single LED Design
- 6.5" 18 AWG Wires
- Operates on 9-16 Volts DC

PRODUCT NUMBERS

011-1530
011-2530 Blue Shortie Livewell
011-3530
011-4530
011-5530 White Shortie Livewell

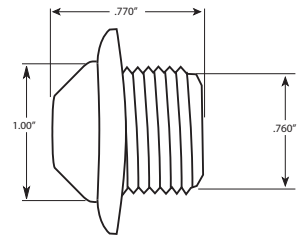

1" Round LED "Shortie" Livewell/Bulkhead Light with White Grommet



DETAILS

- Size: 1.4" dia. x .68" d
- Clear Lens
- Rated for 100,000 hours
- Requires .075" Hold and 0.52" Depth
- Waterproof
- Shock and Vibration Proof
- Single LED Design
- 6.5" 18 AWG Wires
- Operates on 9-16 Volts DC

PRODUCT NUMBERS

011-1540
011-2540 Blue Shortie Livewell
011-3540
011-4540
011-5540 White Shortie Livewell

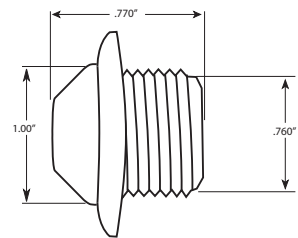

3 LED Recess Starr Light



Shown with stainless steel trim ring

DETAILS

- Operates 9-16 Volt DC System
- Includes Rubber Gasket and Nut
- Fully Potted Electronics
- Requires 1.25" Hole
- Shock and Vibration Proof
- Energy Draw 15-25 mA depending on color
- Corrosion Resistant
- Rated for Underwater Use
- Optional Stainless Steel Trim Ring

PRODUCT NUMBERS

012-2500 - Blue / Clear Lens
012-4500 - Red / Clear Lens
012-5500 - White / Clear Lens
012-9901 - Black Gasket
012-9902 - Stainless Steel Trim Ring

Bulk Std. Pack Qty = 12
Packaged Std. Pack Qty = 6

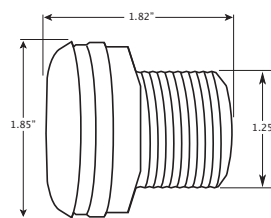

LED Locker Light



- DETAILS**
- Operates 9-16 Volt DC Systems
 - Consumes 90% Less Energy than Incandescent Lights
 - Rated at 100,000 Hours of Service Life
 - Shock and Vibration Proof
 - Waterproof
 - Low Profile Design
 - No Heat Given off by Light
 - Available in 3 or 9 inch lengths
 - Mounts with four #8 flathead screws

- PRODUCT NUMBERS**
- 050-5390 - Three Inch Strip Kit
 - 050-5391 - Three Inch Kit w/ Deutsch End
 - 050-5990 - Nine Inch Strip Kit
 - 050-5991 - Nine Inch Kit w/ Deutsch End

Bulk Std. Pack Qty = N/A
Packaged Std. Pack Qty = N/A

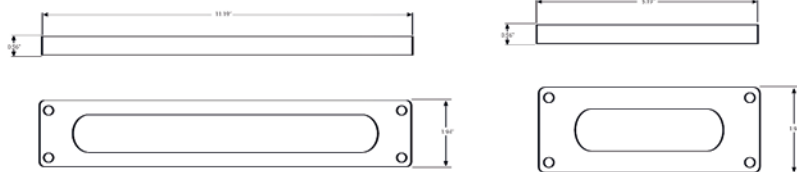

Dual Function Wireless Remote System



- DETAILS**
- Operates 12 Volt DC Systems
 - Two Function Remote (up to 5 amps per function)
 - Operates Up To 75 Feet
 - Conformal Coated Circuit Board
 - Weather Tight Receiver Can Be Mounted Anywhere
 - Re-programmable Transmitter Key Fob Available
 - F.C.C. Approved #OAVTX315

- PRODUCT NUMBERS**
- 590-0000 - 10 Amp Dual Function Wireless Remote System
 - 590-9900 - Replacement Key Fob

Bulk Std. Pack Qty = 12
Packaged Std. Pack Qty = 1

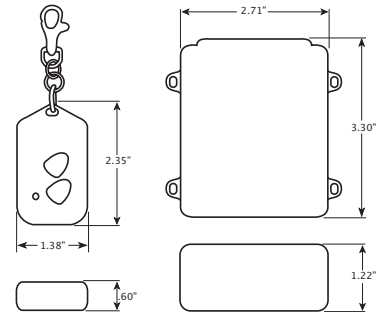

LED Dock Lighting Kit



- DETAILS**
- Operates 12 Volt DC Systems
 - Ideal For Illuminating Decks, Docks, and Walkways
 - Low Cost Insurance For Lighted Pathways
 - Amber Colored LEDs don't attract bugs
 - Optional Wireless Remote System Available

- PRODUCT NUMBERS**
- 090-1000 - Amber Lighting Kit
 - 090-5000 - White Lighting Kit

Packaged Std. Pack Qty = 1

- KIT INCLUDES**
- 1 AC/DC Transformer w/60 Ft. of Attached Wire
 - 1 UL-Listed Junction Box
 - 4 three LED Step Lights
 - 12 single LED Accent Lights
 - 32 Stainless Steel Screws
 - 34 Wire Snap Quick Connects
 - 40 Insulated Staples

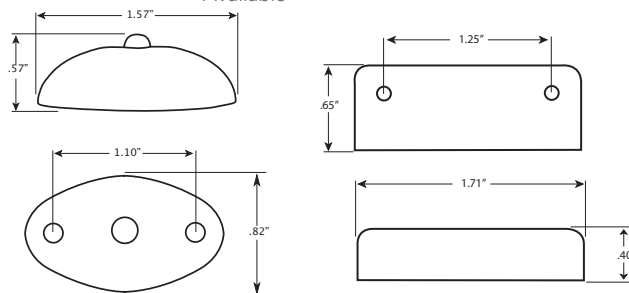

"SETS" Piezo Electronic Drop In Hidden Horn



Optional Stainless Steel Grill Overlay

DETAILS

- 12 or 24 volt DC Systems
- For Vessels Under 12 Meters (39.4 Ft.)
- Uses "SETS" Horn Technology
- Draws Less Than 1/2 Amp
- Unit Is Polarity Protected
- Solid State With No Moving Parts
- Built-in Water Evacuation Drainage System
- Requires 2 1/4" Hole
- Mounting Gasket Included

PRODUCT NUMBERS

- 540-0000 - Black
- 540-0100 - White
- 540-0700 - Cream
- 540-9900 - Stainless Steel Grill Overlay

Bulk Std. Pack Qty = 24
Packaged Std. Pack Qty = 6

COLOR OPTIONS



Black White Cream

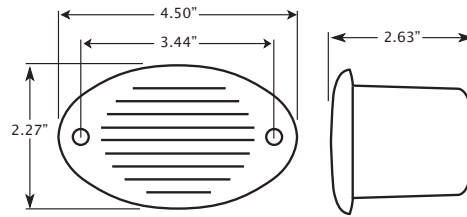

Patent #6559758B2



"SETS" Piezo Electronic Hull Mount Horn



Optional Stainless Steel Grill Overlay

DETAILS

- 12 or 24 Volt DC Systems
- For Vessels Under 12 Meters (39.4 Ft.)
- Uses "SETS" Horn Technology
- Draws Less Than 1/2 Amp
- Unit Is Polarity Protected
- Solid State With No Moving Parts
- Built-in Water Evacuation Drainage System
- Requires Jig Saw or Router
- Mounting Gasket Included

PRODUCT NUMBERS

- 541-0000 - Black
- 541-0100 - White
- 541-0200 - Chrome
- 541-9900 - Stainless Steel Grill Overlay

Bulk Std. Pack Qty = 24
Packaged Std. Pack Qty = 6

COLOR OPTIONS



Black White Chrome

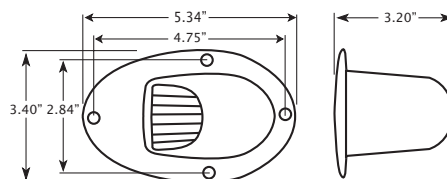

Patent #6559758B2



“SETS” Piezo Electronic Deck Mount Horn



DETAILS

- 12 or 24 Volt DC Systems
- For Vessels Under 12 Meters (39.4 Ft.)
- Uses “SETS” Horn Technology
- Draws Less Than 1/2 Amp
- Unit Is Polarity Protected
- Solid State With No Moving Parts
- Rope Shedding Design
- Forward Facing Presentation
- Mounting Gasket Included
- Patent #6559758B2

PRODUCT NUMBERS

- 542-0000 - Black
- 542-0100 - White

- Bulk Std. Pack Qty = 24
- Packaged Std. Pack Qty = 6

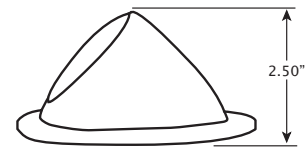
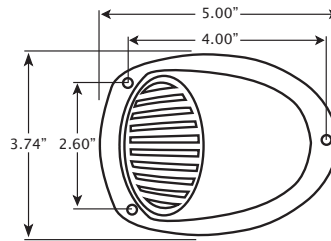

“SETS” Piezo Electronic Hand Held Horn



DETAILS

- Battery Operated
- Weatherproof
- Solid State Electronics
- Shock Resistant Construction
- Contains NO CFCs
- NO Haz Mat
- NO Leaking or Limited Shelf Life
- Meets U.S. Coast Guard Requirements
- Requires One 9-Volt Battery (Not Included)
- Patent #D488,736, #6559758B2
- For vessels under 12 meters (39.4 ft.)

PRODUCT NUMBERS

- 545-2010 - Yellow Sport Horn w/ Cradle
- 545-5010 - Blue Signaling Horn w/ Cradle

- Bulk Std. Pack Qty = N/A
- Packaged Std. Pack Qty = 6

COLOR OPTIONS



Blue Yellow

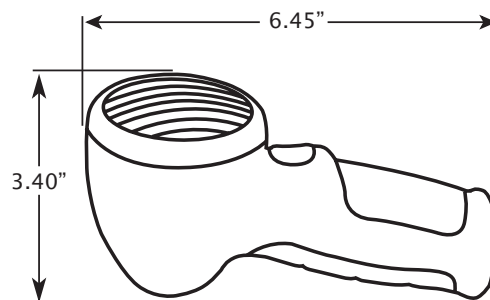

INNOVATIVE USES

- Boating
- Sporting Events
- Emergency / Warning
- Bicycling
- Hiking / Camping
- Hunting
- Work Sites





Proud Member of the Following:

National Marine Distributors Association
National Marine Manufacturers Association
American Boating Yacht Council
National Association of Trailer Manufacturers
Society of Automotive Engineers
Transportation Safety Equipment Institute
National Homebuilders Association
National Fire Protection Association



PO Box 366
109 Progressive Avenue
Roland, Iowa 50236



800-949-4888
Fax: 515-388-5549
www.InnovativeLight.com